



Designs of distinction[®]
Kitchen, Bath & Home
by BWI

Decorative American-Made wood,
materials and metal components for
kitchen, bath and home.

Distributed by:



DIRECT
SUPPLY INC
SURFACE MATERIALS \ CABINETRY \ HARDWARE

TABLE OF CONTENTS



DIRECT
SUPPLY INC
SURFACE MATERIALS \ CABINETRY \ HARDWARE

1055 36th Street SE
Grand Rapids, MI 49508

616-245-4415
sales@directsupplyinc.com
www.directsupplyinc.com



@directsupplyinc



@directsupplyinc



@direct-supply-inc

CATALOG BY PRODUCT

INTRODUCTION

- 1 MATERIALS & FINISHES
- 2 HOW TO READ OUR CATALOG
- 4 SPECIAL CUTS & SERVICES
- 6 MATERIALS
 - 7 TAMBOUR
 - 11 METAL ACCENT TRIM
 - 14 CUT-TO-SIZE MATERIALS
- 19 POSTS, COLUMNS & TABLE LEGS
- 38 END PANELS & METAL BASES
- 42 BUN FEET
- 52 BRACKETS & CORBELS
- 65 CREATE-A-COLUMN™
& HALF ROUND MOULDINGS
- 68 SHELVING
- 75 DECORATIVE MOULDINGS & TILES
- 81 FINISHING TOUCHES &
HARDWARE COMPONENTS
 - 81 GALLERY RAIL
 - 83 OUTLET COVERS & FLOOR VENTS
- 88 BISTRO SHELVING
- 90 WARRANTY INFORMATION & INDEX

©BROWN WOOD INC.
ALL RIGHTS RESERVED 2023
ALL DESIGNS ARE THE EXCLUSIVE PROPERTY OF
BROWN WOOD, INC. AND MAY NOT BE USED OR
REPRODUCED WITHOUT EXPRESS
WRITTEN PERMISSION



RESPONSIBLE
STEWARDS OF THE
ENVIRONMENT

SOLID BRASS FEET AND SLIPPER CUPS

Our new line of Solid Brass Feet & Slipper Cups feature the finest quality cast brass. Cast brass, made of a copper/zinc alloy, is known for its material integrity, smooth surface finish, durability, and strength. Cast brass Feet & Slipper Cups will outlast normal wear and will maintain its bright finish for years to come.



AB: Antique Brass



WR: Flat Black



PB: Polished Brass



CR: Chrome



SB: Satin Brass

ANODIZED ALUMINUM FERRULES, SLEEVES AND METALLIC TRIM

We use a special Aluminum alloy to create our ferrules, metallic trim, and other decorative aluminum accents. This special alloy can be chemically brightened. Our Aluminum finishes are anodized and feature bright chromes, soft satins and deep matte finishes. Anodizing is considered the best method of finishing in order to achieve a true metallic look. Anodized finishes are extremely durable and will not flake, peel or fade. **If exact color is critical to your project, please request color samples.**



WOOD SPECIES

We source only the finest FAS hardwoods for our products. The majority of our products are made from laminated blocks with more than one glue line. We strive to provide the best possible color match between staves, but variations may occur. Variations in color and grain pattern are natural characteristics of wood and are not considered defects.



POWDER COATED STEEL AND METALS

Our steel products are laser cut, Tig welded by skilled craftsmen, and powder coated in a non-toxic, environmentally safe finish. Because powder coating is baked onto the steel, the finish is substantially harder than a wet paint finish. The results provide a finished part that is resistant to scratching, chipping, and peeling and can handle extreme weather conditions with minimal corrosion. In addition, powder coating is environmentally friendly, is non-toxic, emits no harmful fumes, and the powder can be recycled.



Don't forget, custom manufacturing is our specialty. If you don't see what you need, give us a call or submit a request for quote from our website.

ELECTROPLATED WIRE GRILLE FINISHES

Our electroplated Decorative Grilles are hand woven & crimped from superior steel wire. The process of electroplating deposits metal finishes onto the steel through electricity creating both bright and antique finishes. Finishes can vary from run to run. **If exact color is critical to your project, please request samples.**

Sample Kits available on our website.



SS: Stainless Steel Look

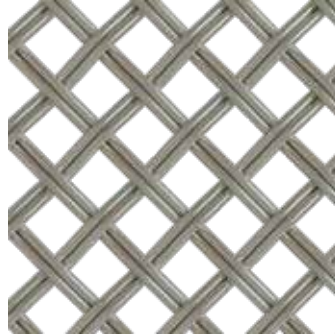

SN: Polished Satin Nickel

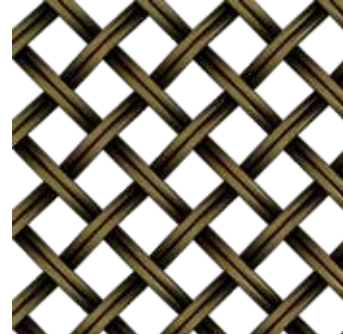

AB: Antique Brass

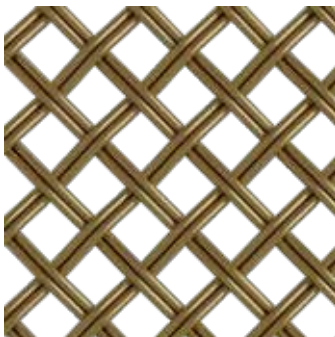

SB: Satin Brass

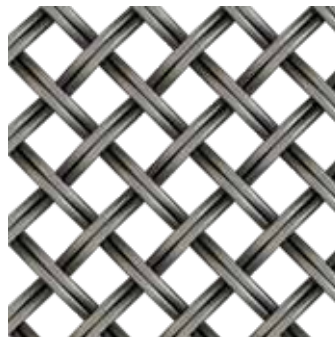

AP: Antique Pewter

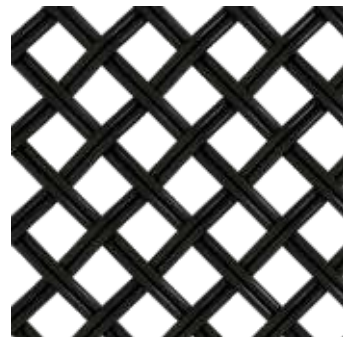

WR: Flat Black



AC: Antique Copper

HOW TO READ OUR CATALOG

This catalog is organized by product category.

Products are grouped by style with available sizes and available species listed beneath the image.

MISSION CORBEL ← Product Name



01601206-1 ← Item SKU. The dash (-) is a placeholder for the material you choose. See price list for all available materials.

2.75" W x 2.625" D

01601205-1

5.75" W x 3.875" D

01601204-1

3.5" W x 3.5" D x

01601203-1

3.5" W x 9" D x 13" L

Available Sizes

Corbels & Brackets



01904993-1

3.75" W x 8.5" D x 13" L

Vertical Mouldings

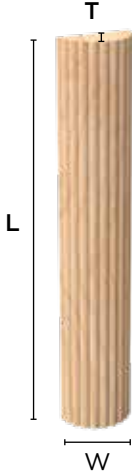

01961520-2

.75" W x .34375" T x 96" L

Posts & Columns
 SQ. or Diameter



01060210-1

3.75" SQ. x 35.25" H

Bun Foot
 SQ. or Diameter



01704110-1

3" DIAM. x 6.125" H

Create-A-Column® Components



01391510-2

2" W x .906" D x 9.4375" L

Horizontal Mouldings



01807000-1

4.25" H x .625" T x 96" L

Tiles



01902025-1

2.875" SQ. x .5" T

SPECIAL WOOD CUTS & SECONDARY SERVICES

We are pleased to offer several options to help you in your design process. Secondary services such as splitting in half, quarter notching, electrical outlet notching, and hanger bolt installation are available on the majority of our columns, legs and bun feet. Additional charges apply.

QUARTER CUT



01QUARTERNOTCH

Quarter notching creates a single quartered piece and a single 3/4 piece. Both pieces are included in purchase.

SPLIT



01SPLITCOLUMN

Split column in half. 1/8" of thickness may be lost due to saw kerf. Both halves are included in purchase.

ANGLE CUT



01ANGLECUT

Product is cut at an angle from corner to corner, full length only. Both pieces are included in purchase.

STOP NOTCH



01STOPNOTCH

Stop notch a column. Let us know how far down you would like notched.

SPLIT BUN FOOT



01SPLITFEET

Split bun foot in half. Both pieces are included in purchase.

HANGER BOLT



01HANGERBOLT

5/16-18 hanger bolt installed in one end. Hanger bolt installed to protrude 1/2".

BOX ROUTE



01BXROUTE

Add an electrical box to your column.

ELECTRICAL BORE



01ELECBORE

A 1/2" hole the entire length of the column.

MOULDING & TAMBOUR TRIM

We will cut your 96" moulding to 92" to reduce shipping costs.

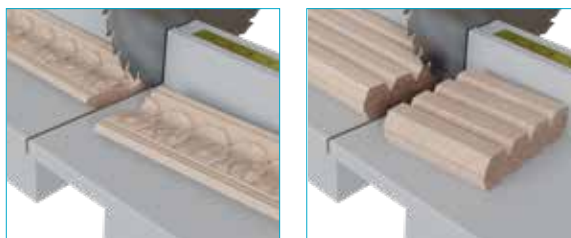



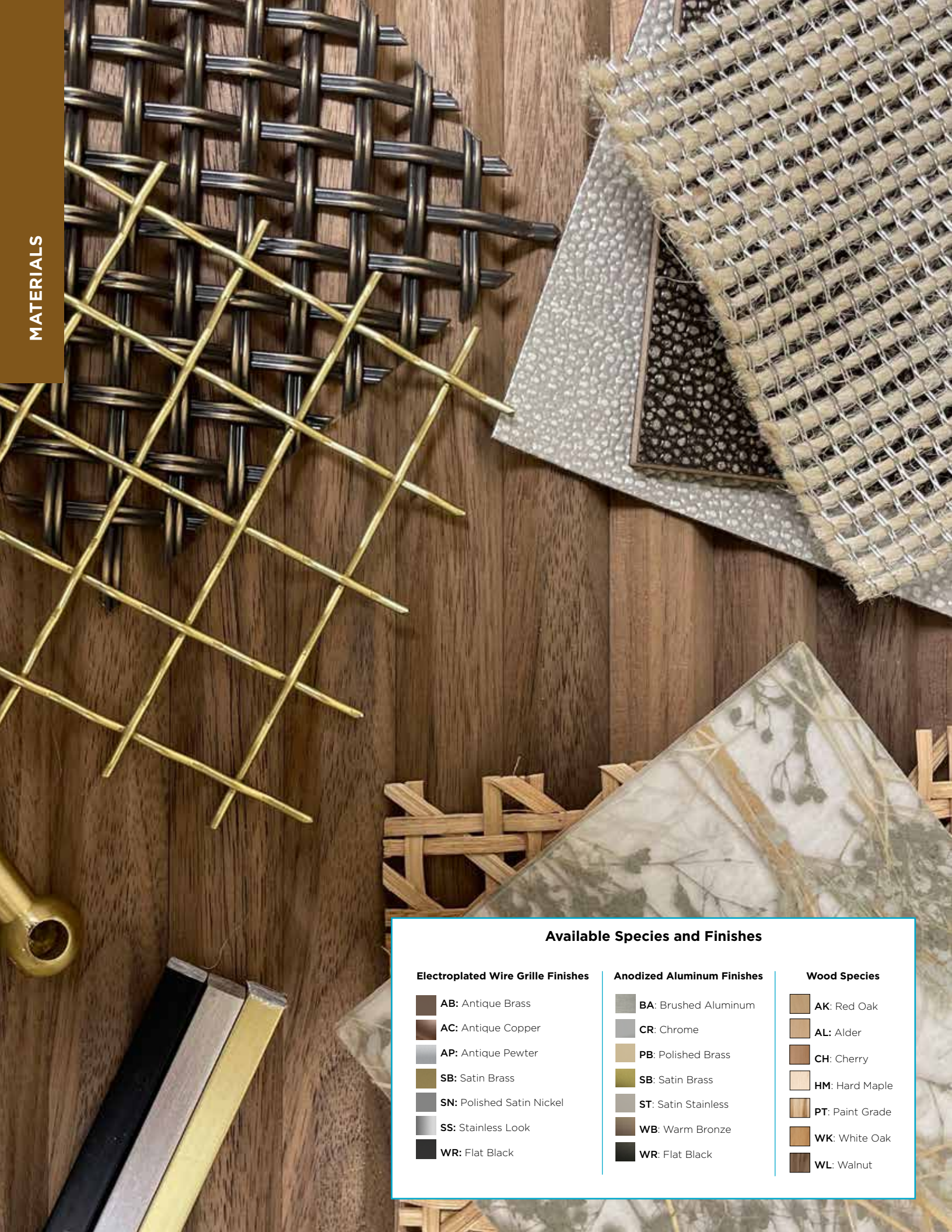



*Please note - not all items can be cut in all the formats above, nor can all columns receive an Electrical Box Notch.
All custom cut products are non-returnable.









Available Species and Finishes







Electroplated Wire Grille Finishes

-  **AB:** Antique Brass
-  **AC:** Antique Copper
-  **AP:** Antique Pewter
-  **SB:** Satin Brass
-  **SN:** Polished Satin Nickel
-  **SS:** Stainless Look
-  **WR:** Flat Black

Anodized Aluminum Finishes

-  **BA:** Brushed Aluminum
-  **CR:** Chrome
-  **PB:** Polished Brass
-  **SB:** Satin Brass
-  **ST:** Satin Stainless
-  **WB:** Warm Bronze
-  **WR:** Flat Black

Wood Species

-  **AK:** Red Oak
-  **AL:** Alder
-  **CH:** Cherry
-  **HM:** Hard Maple
-  **PT:** Paint Grade
-  **WK:** White Oak
-  **WL:** Walnut

LARGE PROFILE FLEXIBLE TAMBOUR

All flexible tambour is available in **Red Oak (AK), Hard Maple (HM), Paint Grade Poplar (PT), Walnut (WL) & White Oak (WK).**

STYLE 203
 1" BEVEL FLEXIBLE TAMBOUR - .313" THICK

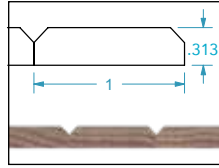

011248203-1
 12"W X .313"T X 48"L
011296203-1
 12"W X .313"T X 96"L

STYLE 204
 1" BEVEL FLEXIBLE TAMBOUR - .5" THICK

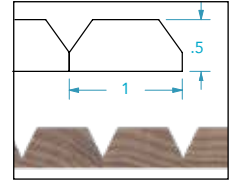

011248204-1
 12"W X .5"T X 48"L
011296204-1
 12"W X .5"T X 96"L

STYLE 105
 1/2" BEAD FLEXIBLE TAMBOUR - .375" THICK

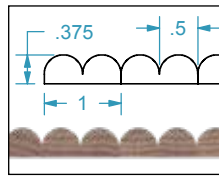

011248105-1
 12"W X .375"T X 48"L
011296105-1
 12"W X .375"T X 96"L

STYLE 104
 1" BEAD FLEXIBLE TAMBOUR - .5" THICK

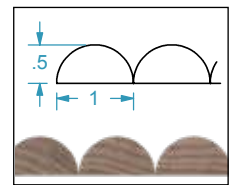

011248104-1
 12"W X .5"T X 48"L
011296104-1
 12"W X .5"T X 96"L

STYLE 207
 1-1/2" BEVEL FLEXIBLE TAMBOUR- .75" THICK

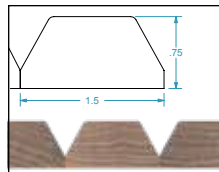

011248207-1
 12"W X .75"T X 48"L
011296207-1
 12"W X .75"T X 96"L

STYLE 206
 1-1/2" BEVEL FLEXIBLE TAMBOUR- .344" THICK

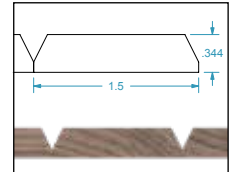
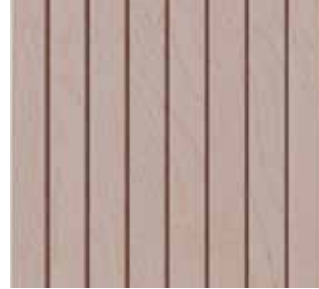

011248206-1
 12"W X .344"T X 48"L
011296206-1
 12"W X .344"T X 96"L

STYLE 106
 1.5" BEAD FLEXIBLE TAMBOUR - .75" THICK

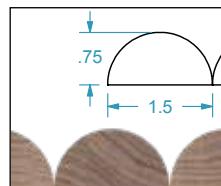

011248106-1
 12"W X .75"T X 48"L
011296106-1
 12"W X .75"T X 96"L

FLEXIBLE TAMBOUR PROFILES

All flexible tambour is available in **Red Oak (AK)**, **Hard Maple (HM)**, **Paint Grade Poplar (PT)**, **Walnut (WL)** & **White Oak (WK)**.

STYLE 103
3/16" BEAD FLEXIBLE TAMBOUR - .313" THICK

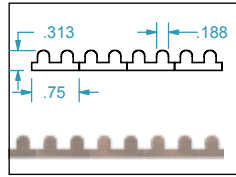

011248103-1
 12"W X .313"T X 48"L
011296103-1
 12"W X .313"T X 96"L

STYLE 101
3/4" BEAD FLEXIBLE TAMBOUR - .313" THICK

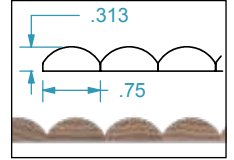

011248101-1
 12"W X .313"T X 48"L
011296101-1
 12"W X .313"T X 96"L

STYLE 202
3/4" BEVEL FLEXIBLE TAMBOUR -.344" THICK

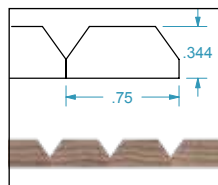

011248202-1
 12"W X .344"T X 48"L
011296202-1
 12"W X .344"T X 96"L

STYLE 201
3/4" BEVEL FLEXIBLE TAMBOUR - .313" THICK

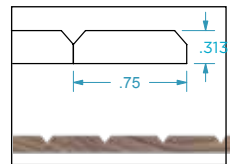

011248201-1
 12"W X .313"T X 48"L
011296201-1
 12"W X .313"T X 96"L

Tambour Sample Kits available on our website.



Featured: Painted/Stained American Hardwood Tambour

FLEXIBLE AND SOLID PANEL TAMBOUR

Tambour Sample Kits available on our website. Solid Tambour available in Alder (AL), Cherry (CH), Hard Maple (HM), Red Oak (AK), Paint Grade Maple (PT), Walnut (WL), and White Oak (WK).

AK, HM, PT, WK, WL

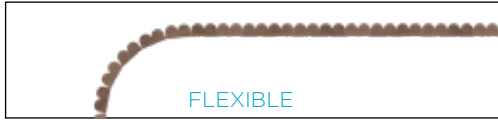

FLEXIBLE

1/4" BEAD FLEXIBLE TAMBOUR
.25" T

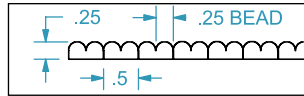

- 011248100-1** 12"W x 48"L x .25"T
- 011296100-1** 12"W x 96"L x .25"T
- 012448100-1** 24"W x 48"L x .25"T

STYLE 100

AK, AL, CH, HM, PT, WK, WL



SOLID PANEL

1/4" BEAD SOLID TAMBOUR
PANEL - .25" T

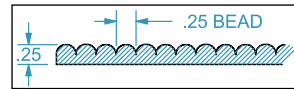

- 012446100-1** 24"W x 46"L x .25"T

AK, HM, PT, WK, WL

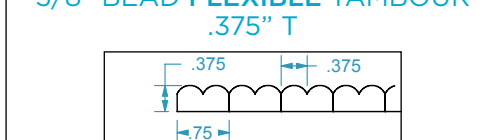

FLEXIBLE

3/8" BEAD FLEXIBLE TAMBOUR
.375" T

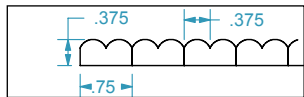

- 011248107-1** 12"W x 48"L x .375"T
- 011296107-1** 12"W x 96"L x .375"T
- 012448107-1** 24"W x 48"L x .375"T

STYLE 107

AK, AL, CH, HM, PT, WK, WL



SOLID PANEL

3/8" BEAD SOLID TAMBOUR
PANEL - .375" T

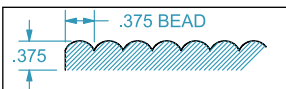

- 012446107-1** 24"W x 46"L x .375"T

AK, HM, PT, WK, WL



FLEXIBLE

.29" BEAD FLEXIBLE TAMBOUR
.375" T

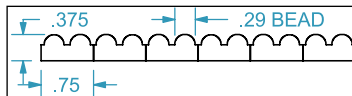

- 011248102-1** 12"W x 48"L x .375"T
- 011296102-1** 12"W x 96"L x .375"T
- 012448102-1** 24"W x 48"L x .375"T

STYLE 102

AK, AL, CH, HM, PT, WK, WL



SOLID PANEL

.29" BEAD SOLID TAMBOUR
PANEL - .375" T

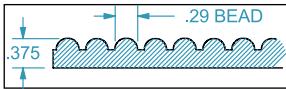

- 012446102-1** 24"W x 46"L x .375"T

AK, HM, PT, WK, WL

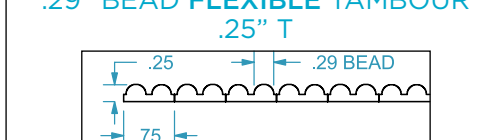

FLEXIBLE

.29" BEAD FLEXIBLE TAMBOUR
.25" T

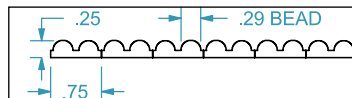

- 011248110-1** 12"W x 48"L x .25"T
- 011296110-1** 12"W x 96"L x .25"T
- 012448110-1** 24"W x 48"L x .25"T

STYLE 110

AK, AL, CH, HM, PT, WK, WL

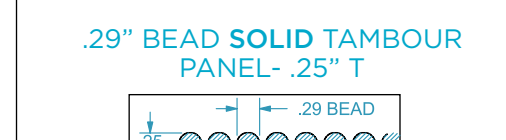

SOLID PANEL

.29" BEAD SOLID TAMBOUR
PANEL - .25" T

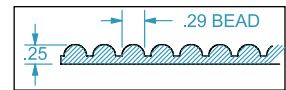

- 012446110-1** 24"W x 46"L x .25"T

Tambour Sample Kits available on our website.

AK, HM, PT, WK, WL



FLEXIBLE

.25" COVE-CUT FLEXIBLE TAMBOUR - .25" T

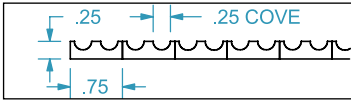

STYLE 402

011248402-1 12"W x 48"L x .25"T
011296402-1 12"W x 96"L x .25"T
012448402-1 24"W x 48"L x .25"T

AK, AL, CH, HM, PT, WK, WL



SOLID PANEL

.25" COVE-CUT SOLID TAMBOUR PANEL - .25" T

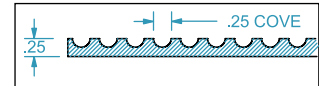

012446402-1 24"W x 46"L x .25"T

AK, HM, PT, WK, WL



FLEXIBLE

1/4" SQUARE FLEXIBLE TAMBOUR - .25" T

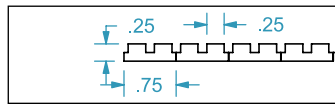

STYLE 302

011248302-1 12"W x 48"L x .25"T
011296302-1 12"W x 96"L x .25"T
012448302-1 24"W x 48"L x .25"T

AK, AL, CH, HM, PT, WK, WL



SOLID PANEL

1/4" SQUARE SOLID TAMBOUR PANEL - .25" T

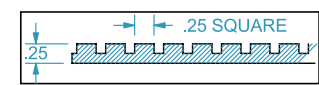

012446302-1 24"W x 46"L x .25"T

AK, HM, PT, WK, WL



FLEXIBLE

1/2" SQUARE FLEXIBLE TAMBOUR - .25" T

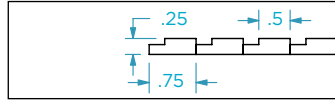

STYLE 304

011248304-1 12"W x 48"L x .25"T
011296304-1 12"W x 96"L x .25"T
012448304-1 24"W x 48"L x .25"T

AK, AL, CH, HM, PT, WK, WL



SOLID PANEL

1/2" SQUARE SOLID TAMBOUR PANEL - .25" T

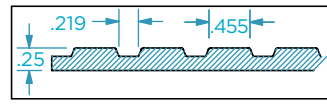

012446304-1 24"W x 46"L x .25"T

AK, HM, PT, WK, WL



FLEXIBLE

5/8" COVE-CUT FLEXIBLE TAMBOUR - .25" T

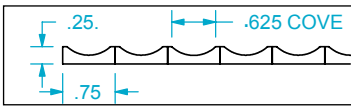

STYLE 403

011248403-1 12"W x 48"L x .25"T
011296403-1 12"W x 96"L x .25"T
012448403-1 24"W x 48"L x .25"T

AK, AL, CH, HM, PT, WK, WL



SOLID PANEL

5/8" COVE-CUT SOLID TAMBOUR PANEL - .25" T

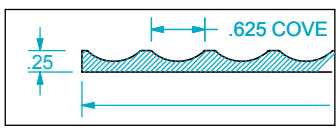

012446403-1 24"W x 46"L x .25"T

Metallic Trim Accents stocked in **Brushed Aluminum (BA)**, **Chrome (CR)**, **Flat Black (WR)**, **Polished Brass (PB)**, **Satin Brass (SB)**, **Satin Stainless (ST)**, & **Warm Bronze (WB)**. All components pictured in flat black.

DECORATIVE ALUMINUM STRAPPING

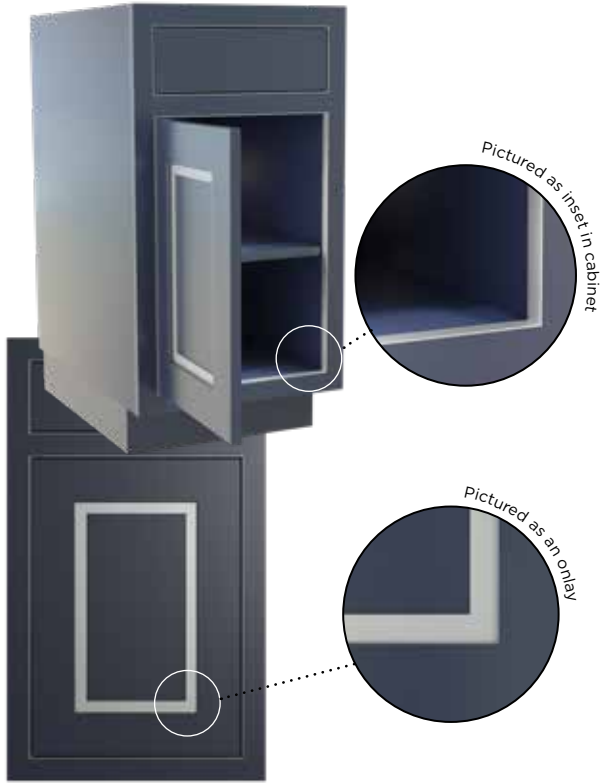

Pictured: .75" Decorative Aluminium Strapping in **Brushed Aluminum**

Use as trim on cabinetry or replace existing & outdated Light Rail Inserts with our new Decorative Aluminum Strapping. Shipped in 72" lengths, the straps can be cut on site to fit your specifications using a lubricated, non-ferrous, high tooth count (96 is recommended) carbide blade designed for cutting metal. We stock strong, double-sided, clear industrial tape that's temperature resistant to adhere to mouldings and cabinet panels. See tape on page 13.



01STRAP7572-1

.75"W x .063"T x 72"L

01110171-1

1.25"W x .094"T x 72"L

ALUMINUM L-CHANNEL

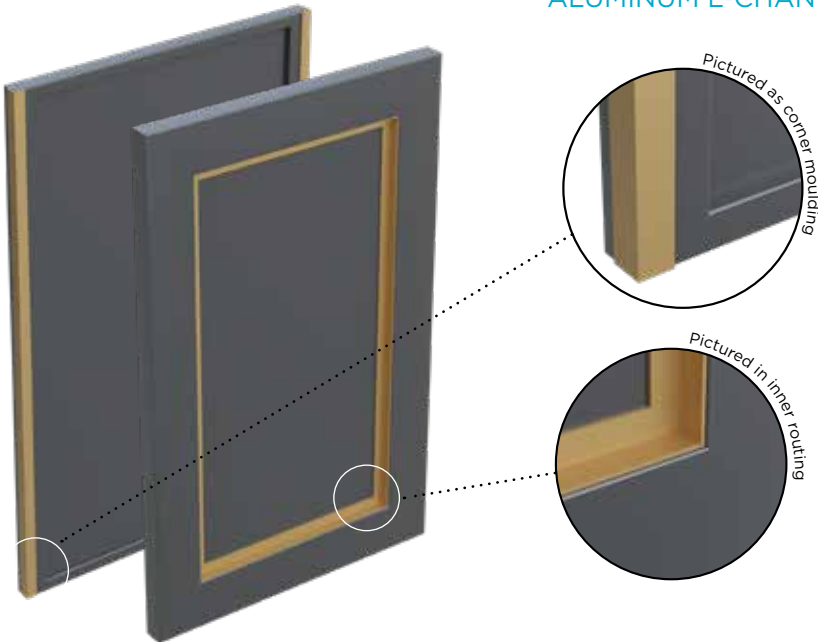

Pictured: .5" Aluminum L-Channel in **Satin Brass**



01110030-1

.5" each way x .063"T x 72"L

01110451-1 NEW SIZE!

.875" each way x .063"T x 72"L

Metal Finishes

- BA:** Brushed Aluminum
- CR:** Chrome
- PB:** Polished Brass
- SB:** Satin Brass
- ST:** Satin Stainless
- WB:** Warm Bronze
- WR:** Flat Black

Designs of distinction®

Kitchen, Bath & Home by BWI

Metallic Trim Accents stocked in **Brushed Aluminum (BA), Chrome (CR), Flat Black (WR), Polished Brass (PB), Satin Brass (SB), Satin Stainless (ST), & Warm Bronze (WB)**. All components pictured in flat black.

.25" x .75" ALUMINUM BAR

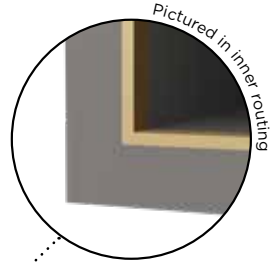

01110788-1
.75"W X .25"T X 72"L

Pictured: .25" x .75" Aluminum Bar in **Satin Brass**

.25" x .25" ALUMINUM BAR

DESIGNER DRIPEDGE™

Fits standard door sizes for 15" and 18" waste can cabinets. Features eased ends and includes pre-applied UHB tape for easy installation. Available in **BA, WR, & SB**.



01110451-12

.875" Each Way x .0625"T x 12.75"L

01110451-14

.875" Each Way x .0625"T x 14.5"L

01110451-15

.875" Each Way x .0625"T x 15.75"L

01110451-17

.875" Each Way x .0625"T x 17.5"L

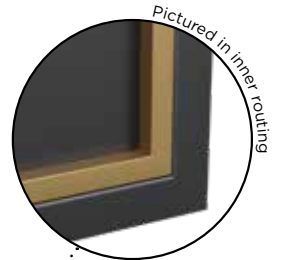

01110810-1
.25"W X .25"T X 72"L

Pictured: .25" Aluminum Bar in **Satin Brass**

Our Decorative Brass Strapping offers an easy way to add a splash of brass to your designs. The flat brass bars are .375" W and 48" L and can be cut on site to fit your specifications using a lubricated, non-ferrous, high tooth count (96 is recommended) carbide blade designed for cutting metal. Combine with our decorative corner straps to finish the look. Available in **Polished Brass (PB)**.

.375" BRASS STRAPPING



01HC1007PB1
 .375"W X .063"T X 48"L

.375" BRASS CORNER STRAP



01HC1006PB1
 1.5"L X .04"T X .375"W

UHB Tape



01TP50-108
 1/2"W X 108'L
01TP50-8
 1/2"W X 8'L

01TP1875-54
 3/16"W X 54'L
01TP1875-8
 3/16"W X 8'L

Double-sided tape, with acrylic-based adhesive, ideal for use with our metal bars, trim and strapping.



Pictured: .375" Brass Strapping and .375" Brass Corner Strap

Decorative Brass hardware is stocked in **Polished Brass (PB)** and **Antique Brass (AB)**.



01HC1005-1
 1.5"L X .08"T X .5"W



01HC1004-1
 1.5"L X .08"T X .375"W



01HC1003-1
 1.5"L X .08"T X 2.1"W



01HC1002-1
 1.5"L X .08"T X 2"W



01HC1009-1
 2"L X 2"D X 0.5"H



01HC1001-1
 1.57"L X 0.12"T X 1.57"W
 Also available in **CR**.



01HC1000-1
 1.57" DIAM X .16"T
 Also available in **CR**.

Metal Finishes

- AB:** Antique Brass
- CR:** Chrome
- PB:** Polished Brass

DECORATIVE GRILLES

Available Cut-to-Size or as whole and half sheets.

All Decorative Grilles available in **Antique Brass (AB)**, **NEW! Antique Copper (AC)**, **Antique Pewter (AP)**, **Satin Brass (SB)**, **Polished Satin Nickel (SN)**, **Stainless Look (SS)** & **Flat Black (WR)**. Finishes created through an electroplating process.

To order Cut-to-Size panels that are ready to install upon delivery, contact us or send us an order form with your panel specifications and a quote will be provided based on square footage used in your project.

Sample Kits available on our website.

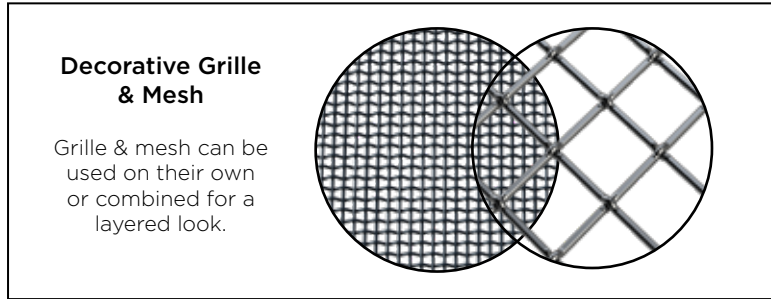

.1875" FLAT SQUARE

Pictured in **Satin Brass**

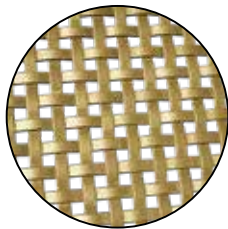

Half Sheets:
013624RE25-1
 36" W x 24" H
011848RE25-1
 18" W x 48" H



Whole Sheet:
013648RE25-1
 36" W x 48" H

.75" PRESSED SINGLE DIAMOND

Pictured in **Polished Satin Nickel**

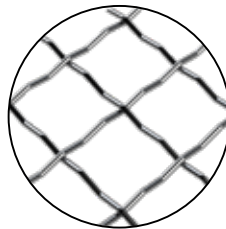

Half Sheets:
013624315C-1
 36" W x 24" H
011848315C-1
 18" W x 48" H

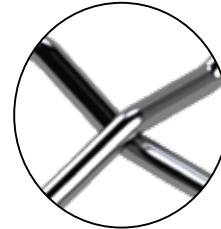

Whole Sheet:
013648315C-1
 36" W x 48" H

.5" STRAIGHT FLAT DIAMOND

Pictured in **Antique Brass**

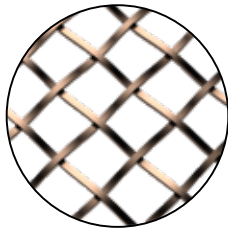

Half Sheets:
013624CG10-1
 36" W x 24" H
011848CG10-1
 18" W x 48" H

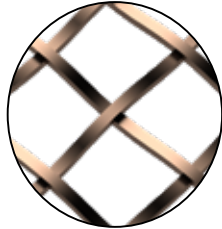

Whole Sheet:
013648CG10-1
 36" W x 48" H

.5" ROUND SINGLE DIAMOND*

Pictured in **Polished Satin Nickel**

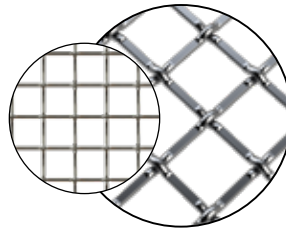



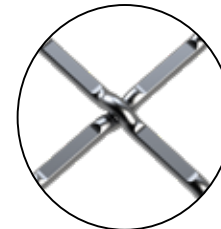



Half Sheets:
0136241214F-1
 36" W x 24" H
0118481214F-1
 18" W x 48" H



Whole Sheets:
0136481214F-1
 36" W x 48" H
0124721214F-1
 24" W x 72" H

Metal Finishes

-  **AB:** Antique Brass
-  **AC:** Antique Copper
-  **AP:** Antique Pewter
-  **SB:** Satin Brass
-  **SN:** Polished Satin Nickel
-  **SS:** Stainless Look
-  **WR:** Flat Black

Custom styles and finishes available upon request.

* Can be installed in the traditional diamond configuration or flipped to square for a contemporary look.

Available Cut-to-Size or as whole and half sheets.

All Decorative Grilles available in **Antique Brass (AB)**, **NEW! Antique Copper (AC)**, **Antique Pewter (AP)**, **Satin Brass (SB)**, **Polished Satin Nickel (SN)**, **Stainless Look (SS)** & **Flat Black (WR)**. Finishes created through an electroplating process.

To order Cut-to-Size panels that are ready to install upon delivery, contact us or send us an order form with your panel specifications and a quote will be provided based on square footage used in your project. Sample Kits available on our website.

5" CHICKEN WIRE

Pictured in **Flat Black**

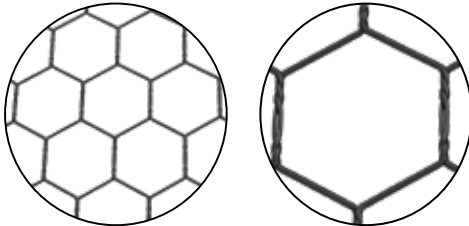

Half Sheets:
0118481220T-1
 18" W x 48" H
0136241220T-1
 36" W x 24" H

Whole Sheet:
0136481220T-1
 36" W x 48" H

Chicken Wire only comes in **AB**, **AP** and **WR**.

.375" FLAT SINGLE DIAMOND*

Pictured in **Antique Brass**

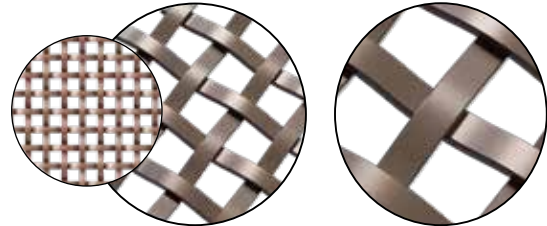

Half Sheets:
011848286S-1
 18" W x 48" H
013624286S-1
 36" W x 24" H

Whole Sheets:
013648286S-1
 36" W x 48" H
012472286S-1
 24" W x 72" H

.75" MULTI-CRIMP SINGLE DIAMOND*

Pictured in **Antique Pewter**

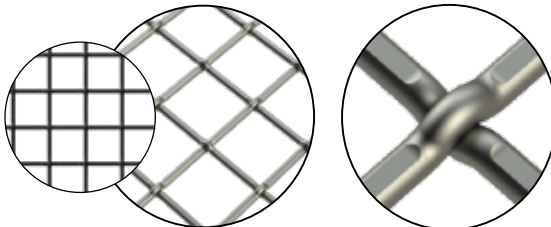

Half Sheets:
011848332P-1
 18" W x 48" H
013624332P-1
 36" W x 24" H

Whole Sheets:
013648332P-1
 36" W x 48" H
012472332P-1
 24" W x 72" H

1" FLAT DOUBLE DIAMOND

Pictured in **Satin Brass**

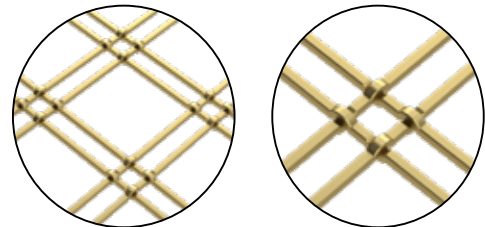

Half Sheets:
01184811614P-1
 18" W x 48" H
01362411614P-1
 36" W x 24" H

Whole Sheets:
01364811614P-1
 36" W x 48" H
01247211614P-1
 24" W x 72" H

DOUBLE-SIDED .375" FLAT/FLUTED*



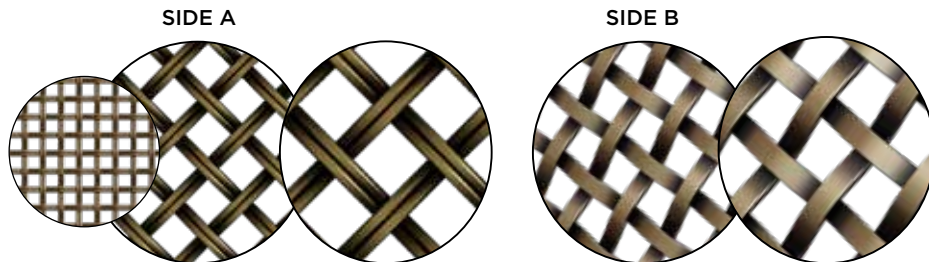



Pictured in **Antique Brass**



Half Sheets:
011848DK08-1
 18" W x 48" H
013624DK08-1
 36" W x 24" H

Whole Sheets:
013648DK08-1
 36" W x 48" H
012472DK08-1
 24" W x 72" H

Metal Finishes

-  **AB:** Antique Brass
-  **AC:** Antique Copper
-  **AP:** Antique Pewter
-  **SB:** Satin Brass
-  **SN:** Polished Satin Nickel
-  **SS:** Stainless Look
-  **WR:** Flat Black

Custom styles and finishes available upon request.

* Can be installed in the traditional diamond configuration or flipped to square for a contemporary look.

Available Cut-to-Size or as whole and half sheets.

All Decorative Grilles with Rosettes only available in **Antique Brass (AB)**. Finishes created through an electroplating process. To order Cut-to-Size panels that are ready to install upon delivery, contact us or send us an order form with your panel specifications and a quote will be provided based on square footage used in your project. Sample Kits available on our website.

.75" MULTI-CRIMP SINGLE DIAMOND WITH .5" ROSETTES

Pictured in **Antique Brass**

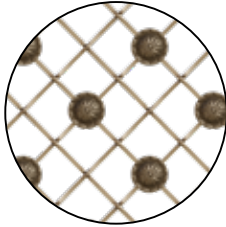

Half Sheets:
011848R332PAB1
 18" W x 48" H
013624R332PAB1
 36" W x 24" H

Whole Sheets:
013648R332PAB1
 36" W x 48" H

1" FLAT DOUBLE DIAMOND WITH .625" DIAMETER ROSETTES

Pictured in **Antique Brass**

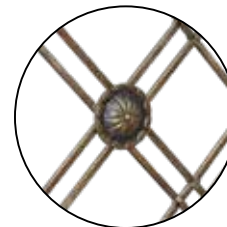

Half Sheets:
011848R614PAB1
 18" W x 48" H
013624R614PAB1
 36" W x 24" H

Whole Sheets:
013648R614PAB1
 36" W x 48" H

HEX RATTAN

Available in rolls or Cut-to-Size.

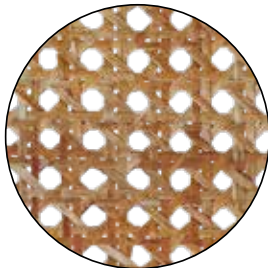

Natural
0136481202NT1
 36" x 48" roll

HERRINGBONE RATTAN

Available in rolls or Cut-to-Size.

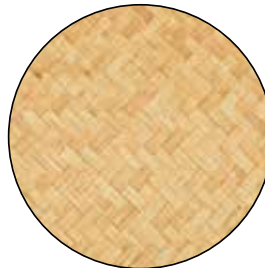

Herringbone
0136481203NT1
 36" x 48" roll

BASKET WEAVE RATTAN

Available in rolls or Cut-to-Size.

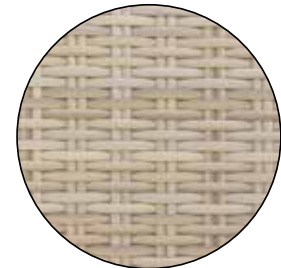

Basket Weave
0136481204NT1
 36" x 48" roll

WHITE LINEN RESIN

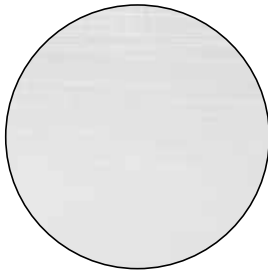

Whole Sheet: 0148481803
 48" x 48"
Half Sheet: 0124481803
 48" x 24"

BOTANICAL RESIN



Whole Sheet: 0148481804
 48" x 48"
Half Sheet: 0124481804
 48" x 24"

NATURAL LEAF RESIN



Whole Sheet: 0148481802
 48" x 48"
Half Sheet: 0124481802
 48" x 24"

Sample Kits available. See QR code on page 17.

Available Cut-to-Size or as sheets.

FINE WIRE MESH

Pictured in Flat Black

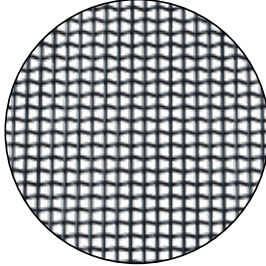

Whole Sheet: 014448MESH-1

41" L x 48" W

Half Sheet: 012248MESH-1

20" L x 48" W

Available in **SB, SN, WR**

GRILLE RETAINER



01DGRETAINER-1

Cut-to-Size to fit your decorative grille.
 Transparent vinyl. Sold per linear foot.

ITALIAN MESH

Made in Italy. Available Cut-to-Size or as sheets.

CHEVRON MESH

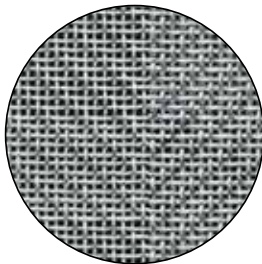

015936107-1

59" W x 36" H

Whole Sheet or Cut-to-Size

Available in **SB, SS**

PINSTRIP MESH

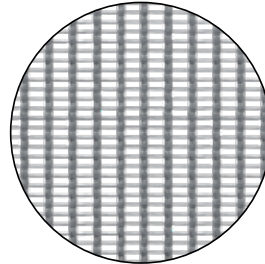

015936104SS1

59" W x 36" H

Whole Sheet or Cut-to-Size

Available in **SS**

BAR CODE MESH

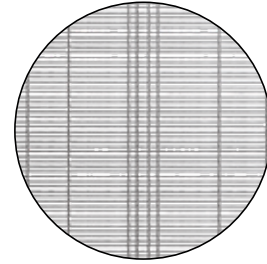

015936116SS1

59" W x 36" H

Whole Sheet or Cut-to-Size

Available in **SS**

BENGAL MESH

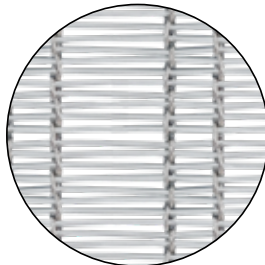

015936118SS1

59" W x 36" H

Whole Sheet or Cut-to-Size

Available in **SS**

JUTE MESH

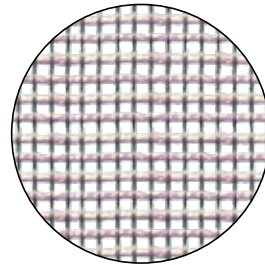

015936112SS1

59" W x 36" H

Whole Sheet or Cut-to-Size

Available in **SS**

DOUBLE-SIDED ECO-FRIENDLY LEATHER

Available Cut-to-Size or as whole and half sheets.

Our leather is an eco-friendly byproduct of the leather industry. Like wood veneer made from compressed paper, this leather is composed of vegetable-tanned leather remnants that are pulverized and mixed with small amounts of tree bark and natural latex. A final layer of resin renders the product highly impervious to wear and tear. Sample kits available.

PEBBLED LEATHER
BRIGHT WHITE

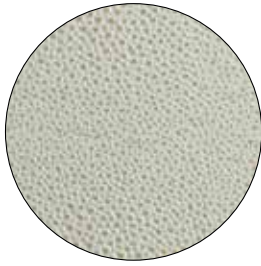

Whole Sheet: 0148481652BW1
48" x 48"
Half Sheet: 0124481652BW1
48" x 24"

PEBBLED LEATHER
WALNUT

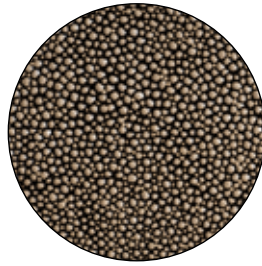

Whole Sheet: 0148481652WL1
48" x 48"
Half Sheet: 0124481652WL1
48" x 24"

PEBBLED LEATHER
ESPRESSO

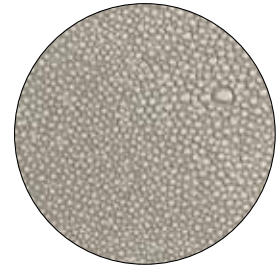

Whole Sheet: 0148481652ES1
48" x 48"
Half Sheet: 0124481652ES1
48" x 24"

PEBBLED LEATHER
FLAT BLACK



Whole Sheet: 0148481652WR1
48" x 48"
Half Sheet: 0124481652WR1
48" x 24"

GRAINED LEATHER
BRIGHT WHITE



Whole Sheet: 0148482216BW1
48" x 48"
Half Sheet: 0124482216BW1
48" x 24"

GRAINED LEATHER
WALNUT



Whole Sheet: 0148482216WL1
48" x 48"
Half Sheet: 0124482216WL1
48" x 24"

GRAINED LEATHER
ESPRESSO



Whole Sheet: 0148482216ES1
48" x 48"
Half Sheet: 0124482216ES1
48" x 24"

GRAINED LEATHER
FLAT BLACK



Whole Sheet: 0148482216WR1
48" x 48"
Half Sheet: 0124482216WR1
48" x 24"



Available Species and Finishes

Wood Species

- AK:** Red Oak
- AL:** Alder
- CH:** Cherry
- HM:** Hard Maple
- HK:** Hickory
- PT:** Paint Grade
- WK:** White Oak
- WL:** Walnut

Metal Sleeve Finishes

- BA:** Brushed Aluminum
- CR:** Chrome
- GL:** Soft Gold
- PB:** Polished Brass
- SB:** Satin Brass
- ST:** Satin Stainless
- WB:** Warm Bronze
- WR:** Flat Black

We offer Special Cuts & Secondary Services to help you in your design process. Secondary services such as splitting in half and electrical outlet routing are available on many of our posts, columns, and table legs. See page 5 for more information.

Featured: Palladian Column

QUEEN ANNE
FRENCH



01180210-1

2.375" SQ. x 36.5" H

QUEEN ANNE
FRENCH FLUTED



01180240-1

2.375" SQ. x 36.5" H

CORNER POST



01550210-1

2.75" SQ. x 36.5" H

CORNER
POST FLUTED



01550240-1

2.75" SQ. x 36.5" H

CH, HM

BUNGALOW

AK, AL, CH, HM, PT, WK, WL



01510228-1

3" SQ. x 34.5" H



01515028-1

5" SQ. x 34.5" H



01510328-1

3" SQ. x 42.25" H

NOUVEAU

AK, AL, CH, HM, PT



01250210-1

3.5" SQ. x 35.25" H



01250310-1

5.5" SQ. x 41" H

2" TABLE POSTS

2" SQUARE

2" SQUARE NOTCHED

AK, AL, CH, HM, HK, PT, WK, WL



01612010-1
 2" SQ. x 29" H

01612010-3
 2" SQ. x 29" H

2" DADOED SQUARE COLUMN
 W/ METAL SLEEVE*

2" SQUARE W/
 TAPERED FOOT

2" SQUARE
 W/ TAPERED
 FOOT & NOTCH

AK, AL, CH, HM, HK, PT, WK, WL



01722910-1
 2" SQ. x 29"H
 with 2" SQ. sleeve

01724529-1
 2" SQ. x 29"H with
 2" SQ. x 4.5"H sleeve

01621025-1
 2" SQ. x 29" H

01621025-3
 2" SQ. x 29" H

*For a complete list of sleeve finishes, see page 1.

2" ISLAND POSTS

2" SQUARE

2" DADOED SQUARE COLUMN
 W/ METAL SLEEVE*

AK, AL, CH, HM, HK, PT, WK, WL



01622010-1

2" SQ. x 35.25" H



01724500-1

2" SQ x 35.25" H
 with 2" SQ. x 4.5"H sleeve



01722010-1

2" SQ. x 35.25" H
 with 2" SQ. sleeve

2" SQUARE NOTCHED

2" SQUARE W/ TAPERED FOOT

AK, AL, CH, HM, HK, PT, WK, WL



01622010-3

2" SQ. x 34.5" H



01622025-3

2" SQ. x 34.5" H



01622025-1

2" SQ. x 35.25" H

*For a complete list of sleeve finishes, see page 1.

3" TABLE AND ISLAND POSTS

SQUARE

TAPERED FOOT

BEVEL CUT

DADOED SQUARE
 COLUMN W/
 METAL SLEEVE

AK, AL, CH, HM, HK, PT, WK, WL



01613010-1
 3" SQ. x 29" H



01613025-1
 3" SQ. x 29" H



01621729-1
 3" SQ. x 29" H



01723001-1*
 3" SQ. x 29" H with
 3" SQ. sleeve

SQUARE

TAPERED FOOT

BEVEL CUT

DADOED SQUARE COLUMN
 W/ METAL SLEEVE

AK, AL, CH, HM, HK, PT, WK, WL



01623010-1
 3" SQ. x 35.25" H



01623025-1
 3" SQ. x 35.25" H



01623017-1
 3" SQ. x 35.25" H



01723010-1*
 3" SQ. x 35.25" H with
 3" SQ. sleeve



01734510-1*
 3" SQ. x 35.25" H with
 3" SQ. 4.5" sleeve

*For a complete list of sleeve finishes, see page 1.

4" TABLE AND ISLAND POSTS

4" SQUARE



01614010-1
 4" SQ. x 29" H

4" SQUARE
 W/ TAPERED FOOT



01614025-1
 4" SQ. x 29" H

4" DADOED
 SQUARE COLUMN
 W/ METAL SLEEVE



01724001-1*
 4" SQ. x 29"H with
 4" SQ. sleeve

AK, AL, CH, HM, HK, PT, WK, WL

4" SQUARE



01624010-1
 4" SQ. x 35.25" H

4" SQUARE
 W/ TAPERED FOOT



01624025-1
 4" SQ. x 35.25" H

4" DADOED
 SQUARE COLUMN
 W/ METAL SLEEVE



01724010-1
 4" SQ. x 35.25" with
 4" SQ. sleeve

AK, AL, CH, HM, HK, PT, WK, WL

*For a complete list of sleeve finishes, see page 1.

5" & 6" TABLE AND ISLAND POSTS

5" DADOED SQUARE COLUMN
 W/ METAL SLEEVE



01725001-1

5" SQ. x 29"H with
 5" SQ. sleeve

Sleeve only available in BA & WR.

5" SQUARE COLUMN
 AK, AL, CH, HM, HK, PT, WK, WL



01615010-1

5" SQ. x 29"H

5" DADOED SQUARE
 COLUMN W/ METAL SLEEVE



01625010-1

5" SQ. x 35.25"H



01725010-1

5" SQ. x 35.25"H
 with 5" SQ. sleeve
 Sleeve only available in BA & WR.

6" SQUARE MITER LOCK

AK, AL, CH, HM, HK, PT, WK, WL



01606010-1

6" SQ. x 34.5"H

6" SQUARE



01626010-1

6" SQ. x 35.25"H

BAR HEIGHT POSTS

2" SQUARE 2" DADOED SQUARE COLUMN W/ METAL SLEEVE* 3" SQUARE 3" DADOED SQUARE COLUMN W/ METAL SLEEVE*

AK, AL, CH, HM, PT



01632010-1
 2" SQ. x 42.25" H



01732010-1
 2" SQ. x 42.25"H
 with 2" SQ. sleeve



01633010-1
 3" SQ. x 42.25" H



01733010-1
 3" SQ. x 42.25"H
 with 3" SQ. sleeve

4", 5" & 6" SQUARE

AK, AL, CH, HM, PT

4" & 5" DADOED SQUARE COLUMN W/ METAL SLEEVE*



01634010-1
 4" SQ. x 42.25" H



01635010-1
 5" SQ. x 42.25" H



01636010-1
 6" SQ. x 42.25" H



01734010-1
 4" SQ. x 42.25"H with
 4" SQ. sleeve



01735010-1
 5" SQ. x 42.25"H with
 5" SQ. sleeve
 Sleeve only available in BA & WR.

*For a complete list of sleeve finishes, see page 1.

JACOBSEN

AK, AL, CH, HM, PT, WL



01270110-1
 2.25" SQ. x 29" H



01280110-1
 2.75" SQ. x 29" H



01270210-1
 2.25" SQ. x 34.5" H



01280210-1
 2.75" SQ. x 34.5" H

JACOBSEN NOTCHED

AK, AL, CH, HM, PT, WL



01270110-3
 2.25" SQ. x 29" H



01280110-3
 2.75" SQ. x 29" H



01270210-3
 2.25" SQ. x 34.5" H

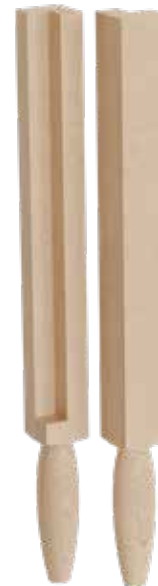

01280210-3
 2.75" SQ. x 34.5" H

DANISH MODERN

AK, AL, CH, HM, PT, WL



01310110-1 2.625" DIAM. x 29" H
01310210-1 2.625" DIAM. x 34.5" H

DANISH MODERN NOTCHED



01310210-3 2.625" DIAM. x 34.5" H
01310110-3 2.625" DIAM. x 29" H

2 SIDED SQUARE TAPERED

AK, AL, CH, HM, PT



01530210-1 3.75" SQ. x 35.25" H
01530310-1 3.75" SQ. x 42.25" H

4 SIDED SQUARE TAPERED

AK, AL, CH, HM, HK, PT, WL



01540210-1 3.75" SQ. x 35.25" H
01540310-1 3.75" SQ. x 42.25" H

ESTATE FLUTED

CH, HM, PT



01040240-1 3.75" SQ. x 35.25" H

ESTATE ROUND

AK, AL, CH, HM, PT, WK, WL



01040210-1 3.75" SQ. x 35.25" H

CHARLESTON BEAD
W/ FOOT



01010285-1
3" SQ. x 35.25" H

CHARLESTON BEAD



01010280-1
3" SQ. x 35.25" H

CHARLESTON BEAD DOUBLE
SQUARE



01020280-1
3" SQ. x 35.25" H

ROPE

AK, AL, CH, HM, PT



01510203-1
3.5" SQ. x 34.5" H

CHARLESTON PEDESTAL

AK, CH, HM, WL



01290180-1
12" DIAM. x 29.5" H



01290280-1
12" DIAM. x 33.5" H

ENGLISH COUNTRY
 AK, AL, CH, HM, HK, PT



01000110-1
 3.75" SQ. x 29.25" H



01210110-1
 5" SQ. x 29.25" H



01000210-1
 3.75" SQ. x 35.25" H

ENGLISH COUNTRY
 AK, AL, CH, HM, PT



01210210-1
 5" SQ. x 35.25" H



01000310-1
 3.75" SQ. x 42.25" H

ENGLISH COUNTRY
 DOUBLE SQUARE
 AK, AL, CH, HM, PT



01030210-1
 3.75" SQ. x 35.25" H

SUMTER DOUBLE SQUARE
 AK, AL, CH, HM, PT



01470110-1
 5" SQ. x 30.25" H



01470210-1
 5" SQ. x 35.25" H

SUMTER WITH FOOT
 AK, AL, CH, HM, PT



01370210-1
 5" SQ. x 35.25" H

GAELIC

AK, AL, CH, HM, PT, WK, WL



01590122-1	01590124-1	01590127-1	01590222-1	01590224-1	01590227-1
3.5" SQ. x 29" H	4.5" SQ. x 29" H	6" SQ. x 29" H	3.5" SQ. x 34.5" H	4.5" SQ. x 35.5" H	6" SQ. x 35.5" H

GAELIC - ROUTED

AK, AL, CH, HM, PT, WK, WL



01590123-1	01590125-1	01590128-1	01590223-1	01590225-1	01590228-1
3.5" SQ. x 29" H	4.5" SQ. x 29" H	6" SQ. x 29" H	3.5" SQ. x 34.5" H	4.5" SQ. x 35.5" H	6" SQ. x 35.5" H

WRIGHT

WRIGHT W/
 DETACHABLE FOOT

KENSINGTON

AK, AL, CH, HM, PT, WK, WL



01040270-1
 3.5" SQ. x 35.25"H



01040275-1
 3.5" SQ. x 35.25"H



01110110-1
 3" SQ. x 29"H



01110210-1
 3" SQ. x 35.25"H

ESTATE SQUARE

AK, AL, CH, HM, PT, WK, WL



01042760-1
 2.75" SQ. x 35.25" H



01040127-1
 2.75" SQ. x 29.25" H



01040160-1
 3.75" SQ. x 29.25" H



01220160-1
 5" SQ. x 29.25" H
 ONLY CH, HM, PT



01220260-1
 5" SQ. x 35.25" H
 ONLY CH, HM, PT



01040260-1
 3.75" SQ. x 35.25" H

COUNTRY FRENCH SQUARE

COUNTRY FRENCH DOUBLE SQUARE

CH, HM, PT



01060160-1

3.75" SQ. x 29.25" H

01060260-1

3.75" SQ. x 35.25" H



01410110-1

5" SQ. x 29" H

01050210-1

3.75" SQ. x 35.25" H

01410210-1

5" SQ. x 35.25" H

COUNTRY FRENCH REEDED

COUNTRY FRENCH

CH, HM, PT



01060220-1

3.75" SQ. x 35.25" H



01060110-1

3.75" SQ. x 29.25" H



01510110-1

5" SQ. x 29.25" H



01510210-1

5" SQ. x 35.25" H



01060210-1

3.75" SQ. x 35.25" H

TRADITIONAL DOUBLE SQUARE

AK, AL, CH, HM, PT

URN

BUFFET



01160210-1
 3.5" SQ. x 34.5" H



01160310-1
 3.5" SQ. x 40.5" H



01560210-1
 3.75" SQ. x 35.25" H



01520210-1
 5" SQ. x 35.25" H



01590210-1
 3.75" SQ. x 34.5" H

ASTER

AK, AL, CH, HM, PT

COLONIAL

TRADITIONAL REEDED

CH, HM, PT

BAROQUE

CH, HM



01510202-1
 3.5" SQ. x 34.5" H



01510200-1
 3.5" SQ. x 34.5" H



01150220-1
 3.5" SQ. x 34.5" H



01610210-1
 3" W x 5.5" D x 34.5" H

*Set of 3 Pieces

ROMAN CLASSIC FLUTED

ROMAN CLASSIC ROPED

AK, AL, CH, HM, PT



01080240-1
 3.75" SQ. x
 35.25" H

01230240-1
 5" SQ. x
 35.25" H

01082740-1
 2.75" SQ. x
 35.25" H

01082730-1
 2.75" SQ. x
 35.25" H

01080230-1
 3.75" SQ. x
 35.25" H

01230230-1
 5" SQ. x
 35.25" H

ROMAN CLASSIC

ROMAN CLASSIC WEAVED

AK, AL, CH, HM, HK, PT

CH, HM



01082710-1
 2.75" SQ. x
 35.25" H

01080210-1
 3.75" SQ. x
 35.25" H

01230210-1
 5" SQ. x
 35.25" H

01080270-1
 3.75" SQ. x
 35.25" H

01230270-1
 5" SQ. x
 35.25" H

EMPIRE ISLAND

AK, AL, CH, HM, PT



01625046-1
 5" SQ. X 35.25" H

MISSION

AK, AL, CH, HM, PT, WK, WL



01510204-1
 3" SQ. x 35.25" H



01240210-1
 3" SQ. x 34.625" H



01090215-1
 3.75" SQ. x 35.25" H



01240310-1
 3.75" SQ. x 42.25" H

COSMO

AK, AL, CH, HM, PT, WK, WL



01100211-1
 3.75" SQ. x 35.25" H

ARTS & CRAFTS



01386050-1
 6.375"W x 1.625"T
 x 34.5"H



01626050-1
 6.375" SQ. X 34.5" H

MADLINE

AK, AL, CH, HM, PT



01100218-1
 6" SQ. x 35.5" H



01110218-1
 3" SQ. x 35.5" H

APEX

AK, AL, CH, HM, PT



01570217-1

3.5" SQ. x 34.5" H

01570317-1

3.5" SQ. x 40.5" H

PALLADIAN

AK, AL, CH, HM, PT, WK, WL



01580217-1

3.5" SQ. x 34.5" H

01580317-1

3.5" SQ. x 40.5" H

IONIC ACANTHUS

CH, HM



01520223-1

6" SQ. x 35.5" H

ACANTHUS



01560222-1

3.75" SQ. x 35.25" H

TULIP

AK, AL, CH, HM, PT









01140210-1

3.5" SQ. x 34.5" H



Available Species

-  **AK:** Red Oak
-  **AL:** Alder
-  **CH:** Cherry
-  **HM:** Hard Maple
-  **WK:** White Oak
-  **WL:** Walnut

**Featured: 3" Thick
Hardwood X-Panel**

Create your own style. Call for a custom quote.
616-245-4415 | sales@directsupplyinc.com

All Hardwood X-Panels available in **Red Oak (AK)**, **Alder (AL)**, **Cherry (CH)**, **Hard Maple (HM)**, **White Oak (WK)**, and **Walnut (WL)**. Custom species, sizes, and configurations available.

TRIMMABLE HARDWOOD X-PANEL

Features 7.5" Trimmable Bottom



01XPN3025LNG-1

25" W x 3" T
 x 34.5" H



01XPN3036LNG-1

36" W x 3" T
 x 34.5" H



01XPN1525LNG-1

25" W x 1.5" T
 x 34.5" H



01XPN1536LNG-1

36" W x 1.5" T
 x 34.5" H

HARDWOOD X-PANEL



01XPNL3025-1

25" W x 3" T x
 34.5" H



01XPNL3036-1

36" W x 3" T
 x 34.5" H



01XPNL1525-1

25" W x 1.5" T
 x 34.5" H



01XPNL1536-1

36" W x 1.5" T x
 34.5" H

All hardwood X-Panels available in **AK, AL, CH, HM, WK, WL**. Custom species, sizes and configurations available.

TRIMMABLE HARDWOOD X-PANEL WITH BACKERS

Features 7.5" Trimmable Bottom



01XPN3025LNG-4

25" W x 3" T
 x 34.5" H



01XPN3036LNG-4

36" W x 3" T
 x 34.5" H



01XPN1525LNG-4

25" W x 1.5" T
 x 34.5" H



01XPN1536LNG-4

36" W x 1.5" T
 x 34.5" H

HARDWOOD X-PANEL BACKERS



01XPNL3025-4

25" W x 3" T x
 34.5" H



01XPNL3036-4

36" W x 3" T
 x 34.5" H



01XPNL1525-4

25" W x 1.5" T
 x 34.5" H



01XPNL1536-4

36" W x 1.5" T
 x 34.5" H

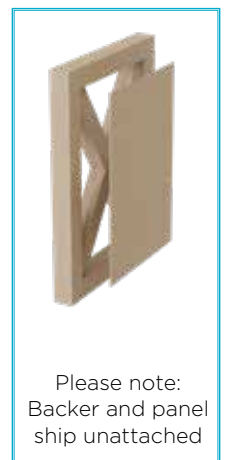

Please note:
 Backer and panel
 ship unattached

Our new X-Bases are eye-catching with clean lines and are sure to provide beautiful support to your tables, countertops & islands for years to come.



STEEL X-BASES
 WR



01XBS2824WR1
 23.46" W x 2.3" T x 28" H



01XBS3424WR1
 24" W x 2.362" T x 34.5" H



01XBS3436WR1
 36" W x 2.362" T x 34.5" H



CONTEMPORARY X-BASES - TABLE HEIGHT
 SS, WR



01XCONT2824WR1
 23.46" W x 3.07" T x 27.3" H











01XCONT2824SS1
 23.46" W x 3.07" T x 27.3" H





Metal Finishes
 **SS:** Stainless Steel
 **WR:** Flat Black - Powder Coated Steel

Available Species and Finishes

Wood Species

-  **AK:** Red Oak
-  **AL:** Alder
-  **CH:** Cherry
-  **HM:** Hard Maple
-  **HK:** Hickory
-  **PT:** Paint Grade
-  **WK:** White Oak
-  **WL:** Walnut

Metal Sleeve Finishes

-  **BA:** Brushed Aluminum
-  **CR:** Chrome
-  **GL:** Soft Gold
-  **PB:** Polished Brass*
-  **SB:** Satin Brass
-  **ST:** Satin Stainless*
-  **WB:** Warm Bronze
-  **WR:** Flat Black

***NEW finishes!**

**Featured: Toe Kick Foot with
Satin Brass Sleeve**

SPECIALTY FEET

HAND CARVED CENTER PEDESTAL

CH, HM



01708310-1
 2.5" H x 16" W

HAND CARVED CORNER PEDESTAL



01708010-1
 8.25" W x 8.25" W x 4" H

HAMPTON MOULDING

AK, AL, CH, HM, PT



01703310-1
 2" H x 1.5" T x 10" W

HAND CARVED
 LEFT & RIGHT PEDESTAL SET

CH, HM



SOLD AS A SET

01708110-1
 4" H x 8.25" W

HAMPTON LEFT

HAMPTON CORNER

HAMPTON RIGHT

AK, AL, CH, HM, PT



01703110-1
 4.5" H x 1.5" T x 6" W



01703010-1
 4.5" H x 1.5" T x 6" L x 6" L



01703210-1
 4.5" H x 1.5" T x 6" W

SPECIALTY FEET

PERLE



01245106-1 2.25" DIAM. x 6" H
01245109-1 2.75" DIAM. x 9" H

ROUND TAPERED

MA, WK, WL



01243006-1 1.5" DIAM. x 6" H
01243009-1 1.87" DIAM. x 9" H

SQUARE TAPERED



01244006-1 1.5" SQ. x 6" H
01244009-1 1.87" SQ. x 9" H

HAND CARVED ACANTHUS CORNER

CH, HM



01707710-1 3.375" SQ. x 4.5" H
01707610-1 3.625" SQ. x 6" H

ACANTHUS



01702022-1 4" DIAM. x 4.5" H

SCROLL

CH, HM, PT



01709010-1 3.25" D. x 3.25" W x 4.5" H

HAND CARVED BELLA SMOOTH

CH, HM



01707410-1 3.75" DIAM. x 8" H

HAND CARVED BELLA FLUTED



01707440-1 3.75" DIAM. x 8" H

SQUARE TURNED FEET

NOUVEAU

METRO

TULIP SQUARE

AK, AL, CH, HM, PT, WK, WL



01700457-1
 4" SQ. x 4" H



01705710-1
 4" SQ. x 4.5" H



01706065-1
 3.5" SQ. x 4.625" H

SUMMIT

LILLE SQUARE

EMPIRE

ENGLISH ESTATE

AK, AL, CH, HM, PT



01705080-1
 4" SQ. x 4.5" H



01750460-1
 4" SQ. x 4" H



01704060-1
 4" SQ. x 4.5" H



01700146-1
 3" SQ. x 4.5" H



01742060-1
 3.5" SQ. x 4.5" H

LIAM

AIDEN

AK, AL, CH, HM, PT, WK, WL



01700627-1
 4.62" SQ. x 6" H



01700327-1
 3.625" SQ. x 4" H

SQUARE AND TAPERED FEET

BUN FEET

CRAFTSMAN CORNER

SQUARE TAPERED

SQUARE CRAFTSMAN

APEX

AK, AL, CH, HM, HK, PT, WK, WL



01705175-1

3.75" W x 3.75" W x 6" H



01705610-1

1.875" SQ. x 6" H



01705112-1

3" SQ. x 6" H



01705150-1

2.75" SQ. x 4" H

KENSINGTON

SQUARE COLUMN BASE

SHAKER

AK, AL, CH, HM, PT



01703510-1

3" SQ. x 4.5" H



01705510-1

3.75" SQ. x 4" H



01705810-1

5" SQ. x 5" H



01705860-1

6" SQ. x 4.5" H



01705715-1

4.5" SQ. x 4.5" H

2" SQUARE LEG
W/ TAPER

3" SQUARE LEG
W/ TAPER

AK, AL, CH, HM, PT, WK, WL

STRATFORD

WRIGHT

AK, AL, CH, HM, HK, PT, WK, WL



01700210-1

2" SQ. x 10" H



01700310-1

3" SQ. x 10" H



01705110-1

2.375" SQ. x 6" H



01704075-1

3" SQ. x 4.5" H
(6.5" overall height)

TOE KICK FEET

TULIP



01706060-1

4" W x 2.5" T x 4.625" H

PALLADIAN

AK, AL, CH, HM, PT



01700018-1

4" W x 2.5" T x 4.5" H

TOE KICK



01705515-1

3.75"W x 2.5"D x 4"H

TULIP

AK, CH, HM



01706061-1

4" W x 2.5" D x 4.125" H

APEX

AK, AL, CH, HM, HK,
PT, WK, WL



01705155-1

2.5" W x 2.5" D x 4" H

TAPERED

HM



01705225-1

3.5" SQ. x 4.5" H



Featuring: Apex Toe Kick Foot

ROUND FEET

BUN FEET

CLASSIC



01705310-1

3.625" DIAM. x 4.5" H

CRAFTSMAN

AK, AL, CH, HM, PT



01760410-1

3.625" DIAM. x 4" H



01704210-1

3.625" DIAM. x 4.5" H

TULIP



01706010-1

3.5" DIAM. x 4.625" H

ABBE



01700011-1

2.5" DIAM. x 4" H

COUNTRY FRENCH

AK, AL, CH, HM, PT



01702510-1

3.625" DIAM. x 4" H



01700015-1

3.875" DIAM. x 4.5" H



01704110-1

3" DIAM. x 6.125" H

MADISON

DANISH MODERN

AK, AL, CH, HM, PT, WK, WL



01704535-1

2.25" DIAM. x 4.5" H



01706035-1

2.25" DIAM. x 6" H



01709035-1

2.25" DIAM. x 9" H

LILLE

LILLE FLUTED

AK, AL, CH, HM, PT



01704010-1

4" DIAM. x 4.5" H



01704040-1

4" DIAM. x 4.5" H

OXFORD

AK, AL, CH, HM, PT



01704910-1

4" DIAM. x 4.5" H

PETITE TULIP

AK, PT



01706005-1

2.75" DIAM. x 3" H

MIXED MATERIALS FEET

ROUND TAPERED
LEGS W/ FERRULE

SQUARE TAPERED
LEGS W/ FERRULE

TIPTOE
W/ FERRULE

HM, WK, WL
 Ferrule finishes: BA, CR, SB, WB, WR



01240006-1

1.5" DIAM. x 6" H

01240009-1

1.87" DIAM. x 9" H

01241006-1

1.5" SQ. x 6" H

01241009-1

1.87" SQ. x 9" H

01242006-1

2.75" DIAM. x 6" H

01242009-1

3.625" DIAM. x 9" H

10" TALL SQUARE LEG W/ METAL SLEEVE

AK, AL, CH, HM, HK, PT, WK, WL

TOE KICK FOOT W/ 4.5" METAL SLEEVE

BA, CR, PB, SB, ST, WB, WR



01721010-1

2" SQ. x 10" H

01731010-1

3" SQ. x 10" H

01704245-1

4" W x 2" T x 4.5" H

01700245-1

2" SQ. x 4.5" H

01700345-1

3" SQ. x 4.5" H

ALUMINUM SLEEVES

BA, CR, GL, NA, SB, ST, PB, WR

Pictured in Chrome



01SLV2-1

2" SQ. OUTER DIM.
x .125" T x 2" H

01SLV3-1

3" SQ. OUTER DIM.
x .125" T x 3" H

01SLV4-1

4" SQ. OUTER DIM. x
.125" T x 4" H

01SLV5-1

5" SQ. OUTER DIM.
x .125" T x 5" H
*BA, WR

For a complete list of sleeve finishes, see page 1. For more individual sleeves & ferrules, see page 51.

CHROME

ANGLE ROUND



01700400CR1
 2.813" PLATE x 5.375" D
 x 4.875" H

5" SQUARE CORNER



01700402CR1
 4" SQ. x 5" H

ROUND CORNER



01700012CR1
 4.134" PLATE x 5.906" D
 x 6" H

STRAIGHT ROUND



01700905CR1
 3.5" DIAM. x 4" H

SOLID BRASS

RUTLAND
 PB, WR



01700408-1
 7.189" H X 4.724"

DEVON
 PB, SB



01700406-1
 5.9" H X 4.04" PLATE

ESSEX
 PB



01700412-1
 7.18" H X 1.57" DIAM.

TYNE
 PB



01700410-1
 5.9" H X 1.60" W X 2.106" PLATE

POWDER COATED STEEL

Pictured in Flat Black

BRISTOL
 WR



01700401WR1
 6.18" H X 3.9375" PLATE

4" APEX
 CR, WR



01704017-1
 3.94" H X 3.74" W

APEX VASA
 AB, CR, SB, PB, WR



01706018-1
 5.9" H X 3.34" PLATE

HAIRPIN
 GL, GR, WR



01710610-1
 5.125" W x 5.125" D x 6" H



01710910-1
 5.25" W x 5.25" D x 9" H

9" feet are ADA Compliant.

ALUMINUM SLEEVES AND FERRULES

SQUARE METAL FERRULES

BA, CR, SB, WB, WR

Pictured in Brushed Aluminum



01FRS1010-1

1" SQ. OUTER DIM.
x .125" T x 1" H



01FRS1254-1

1.25" SQ. OUTER DIM.
x .125" T x 4" H

ROUND METAL FERRULES

BA, CR, SB, WB, WR

Pictured in Brushed Aluminum



01FRC1010-1

.913" OUTER DIAM.
x .125" T x 1" H



01FRC1040-1

.913" OUTER DIAM.
x .125" T x 4" H

ROUND SLIPPER CUPS

PB



01SLPR101-1

1.154" DIAM. X 1.87"H



01SLPR103-1

1.154" DIAM. X 1.87"H

TOE KICK METAL SLEEVES

BA, CR, GL, PB, SB, ST, WB, WR

Pictured in Chrome



01SLV245-1

2" SQ. OUTER DIM.
x .125" T x 4.5" H



01SLV345-1

3" SQ. OUTER DIM.
x .125" T x 4.5" H

SLIPPER CUPS

AB, CR, PB, SB

Pictured in Chrome



01SLPR107-1

2.24" SQ. X 1.93"H

*CR, PB



01SLPR106-1

1.59" SQ. X 1.89"H



01SLPR105-1

1.26" DIAM. X 2.165"H







01SLPR104-1

1.154" DIAM. X 1.87"H

Available Species

Wood Species

-  **AK:** Red Oak
-  **AL:** Alder
-  **CH:** Cherry
-  **HM:** Hard Maple
-  **HK:** Hickory
-  **PT:** Paint Grade
-  **WK:** White Oak
-  **WL:** Walnut

Featured:
Apex Corbel



EMPIRE BRACKET

CONTOUR BRACKET

SIMPLICITY BRACKET

AK, CH, HM

AK, AL, CH, HM, PT



01605510-1

2" W x 7.5" D x 10.973" L

01600300-1

2.5" W x 9" D x 9" L

01607002-1

2.75" W x 6.375" D x 9.375" L

ARTS & CRAFTS
BRACKET

AK, AL, CH, HM, PT, WL

COUNTRY BRACKET

CH, HM

BAUHAUS BRACKET

AK, CH, HM, WK, WL
 Arch: BA, WR



01607012-1

5" W x 7.5" D x 11.5" L

01600004-1

1.5" W x 9" D x 6" L

01600006-1

2.125" W x 7" D x 9" L

01600016-1

2.125" W x 9" D x 12" L

Metal Finishes

- BA: Brushed Aluminum
- WR: Flat Black



Featured: 01605008-1 in Walnut

LEXINGTON BAR BRACKET

AK, AL, CH, HM, PT, WK, WL



01605008-1
 2.5" W x 10" D x 7.5" L



01605009-1
 1.5" W x 10" D x 7.5" L



01605006-1
 2.5" W x 10" D x 5" L



01605007-1
 1.5" W x 10" D x 5" L

TRIAD CORBEL-NARROW

AK, AL, CH, HM, PT, WK, WL



01607003-1

2.875" W x 2.875" D x 12" L



01607009-1

2.875" W x 9" D x 12" L



01607008-1

2.875" W x 7" D x 9" L

PORTRAIT CORBEL

HM



01600009-1

3" W x 8" D x 12" L

TRIAD CORBEL

AK, AL, CH, HM, PT, WK, WL



01607006-1

7.5" W x 6" D x 8.375" L



01607007-1

3.75" W x 4" D x 5.5" L

PLAIN NOUVEAU CORBEL

AK, AL, CH, HM, PT



01601400-1

5.5" W x 9" D x 13" L



01601300-1

5.5" W x 2.75" D x 13" L



01601100-1

3.5" W x 3.875" D x 6.831" L

APEX CORBEL

AK, CH, HM, WK



01607317-1

6" W x 8" D x 14" L



01607217-1

3.875" W x 5" D x 8.75" L



01607117-1

3" W x 3.875" D x 7" L

SIMPLICITY CORBEL

AK, AL, CH, HM, PT, WK, WL



01607004-1

5.5" W x 6.875" D x 7.5" L



01607001-1

4.5" W x 5.75" D x 5" L



01607005-1

3.5" W x 4.125" D x 4.5" L

REVIVAL CORBEL

AK, AL, CH, HM, PT



01604510-1

3.75" W x 9" D x 14" L



01604505-1

3.75" W x 9" D x 9" L



01604500-1

1.25" W x 5" D x 5" L

OPEN ARTS & CRAFTS CORBEL

CH, HM



01607013-1

4.5" W x 7.5" D x 14" L

ARTS & CRAFTS CORBEL

AK, AL, CH, HM, PT, WK, WL



01607010-1

4.5" W x 7.5" D x 14" L



01607011-1

3.75" W x 5.813" D x 9" L

PLAIN SHAKER CORBEL

AK, AL, HM, PT



01606005-1

5" W x 5.313" D x 9" L

SHAKER CORBEL

AK, AL, CH, HM, PT, WK, WL



01606002-1

3.875" W x 3.5" D x 6.75" L



01606001-1

5.25" W x 6.75" D x 13.25" L



01606003-1

6.625" W x 7.5" D x 16" L

CRAFTSMAN CORBEL

AK, AL, CH, HM, PT, WK, WL



01608001-1

1.25" W x 1.5" D x 3" L



01608009-1

2.75" W x 6" D x 10" L



01608010-1

3.5" W x 8" D x 12" L



01608008-1

3.5" W x 8" D x 12" L

CRAFTSMAN CORBEL

AK, AL, CH, HM, PT, WK, WL



01608007-1

1.5" W x 8" D x 12" L



01608013-1

1.25" W x 2.75" D x 18" L



01608011-1

7" W x 10" D x 34" L
 *AK, AL, CH, HM, PT

MISSION CORBEL

AK, AL, CH, HM, PT, WK, WL



01601206-1

2.75" W x 2.625" D x 6" L



01601205-1

5.75" W x 3.875" D x 9" L



01601204-1

3.5" W x 3.5" D x 13" L



01601203-1

3.5" W x 9" D x 13" L

PALLADIAN CORBEL

AK, AL, CH, HM



01600318-1

3" W x 3.875" D x 7" L



01600418-1

4" W x 5" D x 8.75" L



01600518-1

6" W x 8" D x 14" L

PINNACLE CORBEL

CH, HM



01607316-1

9" W x 7.25" D x 12" L

01607216-1

5.5" W x 5" D x 8" L

HAND CARVED GRAPE CORBEL

CH, HM



01901005-1

5.5" W x 7" D x 15" L

01901003-1

3.5" W x 8" D x 13" L

MADELINE CORBEL

AK, CH, HM



01607315-1

4" W x 9.5" D x 14" L

01607215-1

2.5" W x 6.125" D x 8" L

INFINITY CORBEL

AK, CH, HM



01600937-1

4.5" W x 5.75" D x 9.5" L

01600637-1

3.5" W x 3.875" D x 6.65" L

ACANTHUS CORBELS

CH, HM



01901105-1

3.5" W x 8" D x 13" L

01901001-1

7.875" W x 6" D x 14.5" L

01901002-1

5" W x 4.5" D x 12" L

01901009-1

3" W x 1.75" D x 4.5" L
 SOLD AS A SET OF 2

01901108-1

6.5" W x 2.5" D x 15" L

ACANTHUS CORBELS

CH, HM



01901107-1

3" W x 1.323" D x 6" L

01609001-1

6" W x 4.875" D x 14" L

01609003-1

3.5" W x 3.5" D x 10" L

01609004-1

3" W x 2" D x 5" L

GAELIC CORBEL

CH, HM, WK



01600928-1

4.75" W x 5.75" D x 9" L



01600628-1

3.5" W x 3.875" D x 6.625" L

CELTIC CORBEL

CH, HM, WK



01601427-1

5.5" W x 7.125" D x 14" L



01600927-1

4.75" W x 5.75" D x 9.5" L



01600627-1

3.5" W x 3.875" D x 6.625" L

CORINTHIAN CORBEL

CH, HM, PT



01605002-1

5.625" W x 6.5" D x 14.5" L



01605001-1

4.75" W x 5.5" D x 9.625" L



01605000-1

3.875" W x 3" D x 8" L



01605005-1

3.5" W x 7" D x 14" L

CORINTHIAN CORBEL

CH, HM, PT



01904991-1

3.75" W x 8.5" D x 13" L



01904990-1

2.625" W x 2.5" D x 4.5" L



01901004-1

5.25" W x 4.5" D x 12.5" L







01904993-1

3.75" W x 8.5" D x 13" L



Available Species

Wood Species

-  **AK:** Red Oak
-  **AL:** Alder
-  **CH:** Cherry
-  **HM:** Hard Maple
-  **HK:** Hickory

Featured: Plain Half Round Moulding - Series 150

PLAIN HALF ROUND
 MOULDING

AK, AL, CH, HM



SERIES 200
01962010-2

2" W x 1" T x 96" L

SERIES 150
01961510-2

1.5" W x .75" T x 96" L

ROPED HALF
 ROUND MOULDING

AK, AL, CH, HM, HK



SERIES 150
01961530-2

1.5" W x .75" T x 96" L

FLUTED HALF
 ROUND MOULDING

AK, AL, CH, HM



SERIES 150
01961540-2

1.5" W x .75" T x 96" L

SERIES 200
01962040-2

2" W x 1" T x 96" L

Series 150 Includes 1.5" Half Round Mouldings and Fits Spaces 2.5" or Wider.
 Series 200 Includes 2" Half Round Mouldings and Fits Spaces 3" or Wider.

REEDED HALF
 ROUND MOULDING

AK, AL, CH, HM, HK

AK, AL, CH, HM



SERIES 150
01961520-2

1.5" W x .75" T x 96" L



SERIES 200
01962020-2

2" W x 1" T x 96" L

PLAIN

AK, AL, CH, HM



01384210-2

2.5" W x 1.25" T x 36" H

FLUTED



01384240-2

2.5" W x 1.25" T x 36" H

150 COMBO SPINDLE

AK, AL, CH, HM, HK



SERIES 150
01391510-2

2" W x .906" D x 9.438" L

CENTER SPINDLES

AK, AL, CH, HM



SERIES 150
01311510-2

2.125" W x 1" D x 3" L



SERIES 200
01312010-2

2.875" W x 1.41" D x 3.5" L

END BLOCKS

AK, AL, CH, HM



SERIES 150
01331510-2

2.5" W x 1.19" D x 5.75" L



SERIES 200
01332010-2

3" W x 1.4" D x 5.75" L

END SPINDLES



SERIES 150
01322010-2

3" W x 1.4" D x 3.5" L







SERIES 200
01321510-2

2.5" W x 1.15" D x 3" L

Available Species and Finishes

Wood Species

-  **AK:** Red Oak
-  **AL:** Alder
-  **CH:** Cherry
-  **HM:** Hard Maple
-  **HK:** Hickory
-  **PT:** Paint Grade
-  **WK:** White Oak
-  **WL:** Walnut

Metal Finishes

-  **GL:** Gold
-  **GR:** Gun Metal Grey
-  **SS:** Stainless Steel
-  **WR:** Flat Black
-  **NA:** Natural Aluminum
-  **WR:** Flat Black
-  **WH:** White

**Featured: Natural Aluminum
Slimline Channel Shelf and
9" Round Tapered Legs**

Our floating shelves include hidden shelf supports. Hidden shelf supports can be purchased separately for use in your custom projects.

**CONTEMPORARY FLOATING CORNER SHELF
 W/ HIDDEN STEEL SUPPORT**

AK, AL, CH, HM, WK, WL, PT

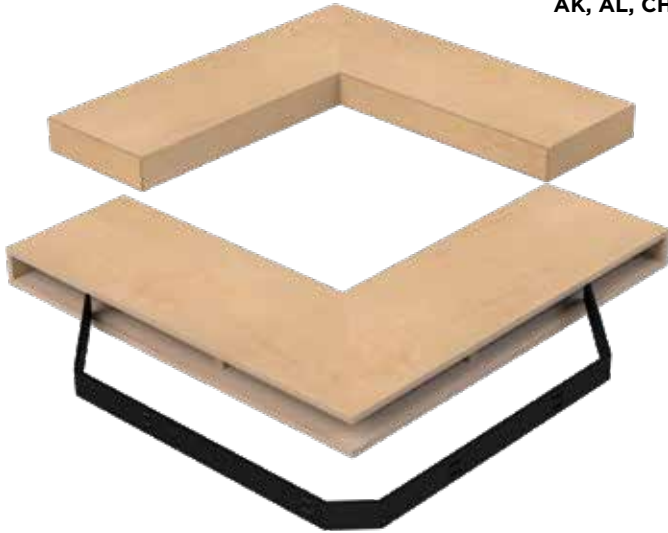

01MFL103030-1

10" D x 2.5" T x 30" Each Way



01MFL102424-1

10" D x 2.5" T x 24" Each Way

CONTEMPORARY FLAT CORNER SHELF

AK, AL, CH, HM, WK, WL, PT



01MSH123030-1

12" D x .75" T x 30" Each Way



01MSH122424-1

12" D x .75" T x 24" Each Way

CONTEMPORARY FLOATING LINEAR SHELF W/ HIDDEN STEEL SUPPORT

AK, AL, CH, HM, WK, WL, PT



01MFL102410-1

10" D x 2.5" T x 24" L



01MFL103610-1

10" D x 2.5" T x 36" L

Custom sizes available!

TEXTURED
 AK, AL, CH, HM, WL



**TEXTURED FLOATING CORNER SHELF
 W/ HIDDEN STEEL SUPPORT**



01FL103030-1

10" D x 2.5" T x 30" Each Way

TEXTURED FLAT CORNER SHELF



01SH123030-1

12" D x .75" T x 30" Each Way

**TEXTURED FLOATING SHELF
 W/ HIDDEN STEEL SUPPORT**



01FL102410-1

10" D x 2.5" T x 24" W

TEXTURED FLAT SHELF



01SH083610-1

8" D x .75" T x 36" W



01SH086010-1

8" D x .75" T x 60" W



01SH123610-1

12" D x .75" T x 36" W



01FL103610-1

10" D x 2.5" T x 36" W



01SH126010-1

12" D x .75" T x 60" W

FLOATING SHELF SUPPORT BRACKETS

9" HIDDEN SHELF SUPPORT



01980109WR1

9.75" W x 8" D x 1.75" H

For use with any floating shelf.

16" HIDDEN SHELF SUPPORT



01980116WR1

16" W x 8" D x 1.75" H

For use with any floating shelf.

HIDDEN CORNER SHELF SUPPORT



01981515WR1

21.718" W Each Way x 1.65" H

For use with 24" x 24" corner shelf.

22.5" HIDDEN SHELF SUPPORT



01981022WR1

22.25" W x 8" D x 1.75" H

For use with any floating shelf.



01982222WR1

28.75" W Each Way x 1.75" H

For use with 30" x 30" corner shelf.

All Brackets on this page include matching hardware and no marr tabs.

TRUSS BRACKETS - HEAVY DUTY

GR, GL, SS, WR



12" TRUSS BRACKET

01651260-1

2" W x 12.5" D x 7.75" L



8" TRUSS BRACKET

01650860-1

2" W x 8.5" D x 6" L

MID-CENTURY TRIANGLE BRACKET

GR, GL, SS, WR

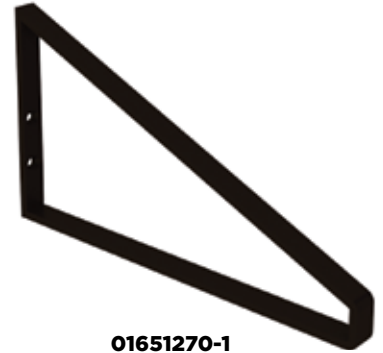

01651270-1

.75" W x 12.625" D x 6.875" H

TRUSS STRAPS - HEAVY DUTY

GR, GL, SS, WR

Works with any 3/4" shelf.



12" TRUSS STRAP

01651250-1

1" W x 12.75" D x 4.5" L



8" TRUSS STRAP

01650850-1

1" W x 8.75" D x 4.5" L

APEX CORNER STRAPS W/ MATCHING LAG BOLTS

Apex Corner Straps work with multiple sized columns, legs, shelves, and corbels. These 2" & 3" straps are an ideal way to add a touch of metal to designs. Each strap comes complete with pyramid head screws in matching finishes.



Pictured: Apex Corner Strap

APEX CORNER STRAPS

GL, GR, WR

Pictured in Flat Black



01STR200-1

2" Each Way x .125" T x 1" H



01STR300-1

3" Each Way x .125" x 1.5" H

BRASS APEX STRAPS

AB, PB





Pictured in Polished Brass



01HC1008-1

2" Each Way x .188" T x 1.5" H

Metal Finishes



-  GL: Gold
-  GR: Gun Metal Grey
-  SS: Stainless Steel
-  WR: Flat Black

SLIMLINE CHANNEL SHELVING



All Slimline Shelving includes heavy duty, flushmount, Contractor Grade French Cleat hanging system. Walldog™ screws and leveler included.

Metal Finishes

-  **NA:** Natural Aluminum
-  **WR:** Flat Black
-  **WH:** White

Featuring: Slimline Channel Shelves in Natural Aluminum

SLIMLINE CHANNEL SHELF - ALUMINUM

NA, WH, WR

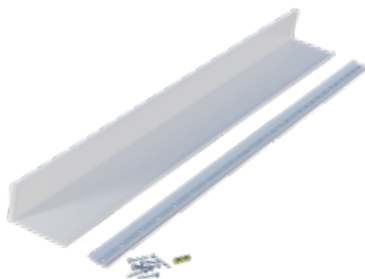

01CHSHLF0424-1

2.5" H x 24" W x 4.125" D

01CHSHLF0448-1

2.5" H x 48" W x 4.125" D

01CHSHLF0436-1

2.5" H x 36" W x 4.125" D

DEEP SLIMLINE CHANNEL SHELF - ALUMINUM

NA, WH, WR



01CHSHLF0624-1

2.5" H x 24" W x 6.125" D

01CHSHLF0648-1

2.5" H x 48" W x 6.125" D

01CHSHLF0636-1

2.5" H x 36" W x 6.125" D

SLIMLINE CHANNEL SHELF - HARDWOOD



Featuring: Slimline Channel Shelves in Walnut

All Slimline Shelving includes heavy duty, flushmount, Contractor Grade French Cleat hanging system. Walldog™ screws and leveler included.

SLIMLINE CHANNEL SHELF

AK, AL, CH, HM, WK, WL, PT







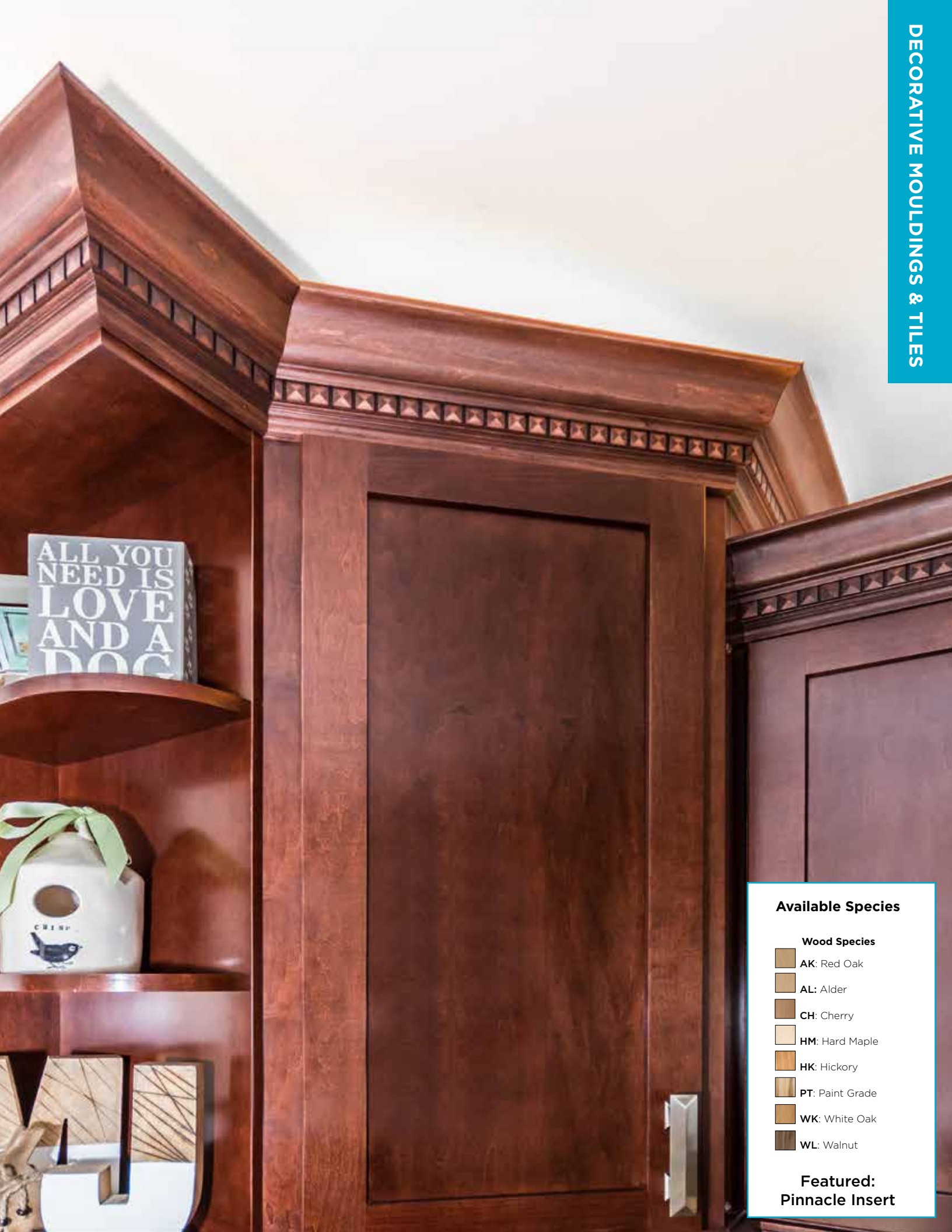



- 01CHSHLF0424-1**
2.75" H x 24" W x 5.125" D
- 01CHSHLF0436-1**
2.75" H x 36" W x 5.125" D

- 01CHSHLF0448-1**
2.75" H x 48" W x 5.125" D
- 01CHSHLF0460-1**
2.75" H x 60" W x 5.125" D



Available Species

Wood Species

-  **AK:** Red Oak
-  **AL:** Alder
-  **CH:** Cherry
-  **HM:** Hard Maple
-  **HK:** Hickory
-  **PT:** Paint Grade
-  **WK:** White Oak
-  **WL:** Walnut

**Featured:
Pinnacle Insert**

PANEL MOULDING
 AK, AL, CH, HM



01806000-1
 3.5" H x .8125" T x 96" L

DECO BASE MOULDING
 AK, AL, CH, HM



01827578-1
 4.5" H x .75" T x 96" L

HARDWOOD SHIPLAP
 AK, AL, CH, HM, PT, WK, WL



01SHIPLAP-1
 5.375" W x .375" T x 96" L

CROWN MOULDING
 AK, AL, CH, HM

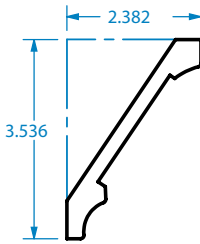

01807000-1
 4.25" H x .625" T x 96" L

TRADITIONAL CROWN MOULDING
 AK, AL, CH, HM



01807500-1
 5" H x .8125" T x 96" L

REVIVAL CROWN MOULDING
 AK, AL, CH, HM

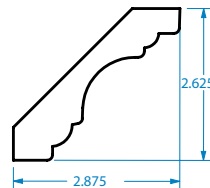

01807375-1
 3.875" H x .84" T x 96" L



Featuring: Slimline Contemporary Light Ready Light Rail[®] Moulding

All mouldings **AK, AL, CH, HM**

SLIMLINE TRADITIONAL
 LIGHT READY LIGHT RAIL[®] MOULDING



01860510-1
 .625" H x 1.625" T x 96" L

SLIMLINE CONTEMPORARY
 LIGHT READY LIGHT RAIL[®] MOULDING



01860520-1
 .625" H x 1.625" T x 96" L

TRADITIONAL
 LIGHT READY LIGHT RAIL[®] MOULDING



01MB867510-1
 1.75" H x 1.625" T x 96" L

CONTEMPORARY
 LIGHT READY LIGHT RAIL[®] MOULDING



01MB867520-1
 1.75" H x 1.625" T x 96" L

Designs of distinction®

Kitchen, Bath & Home
by BWI

Add custom detail above or below cabinetry, on and around hoods, bathroom vanities, and more. Our inserts can be used on their own as an accent or paired with our mouldings. Inserts fit our 01806000-1, 01807000-1, 01807500-1, 01MB867510-1, and 01MB867520-1. Inserts and mouldings are purchased separately.



Pictured: Infinity Insert in Crown Moulding

BAROQUE INSERT

CH, HM



01960745-1

.72" H x .25" T x 96" L



01960145-1

2.2" H x .375" T x 96" L

INFINITY INSERT

AK, CH, HM



01960737-1

.72" H x .28" T x 96" L



01960137-1

2.2" H x .75" T x 96" L

GAELIC INSERT

CH, HM, WK



01960727-1

.72" H x .25" T x 96" L



01960127-1

2.2" H x .41" T x 96" L

ACANTHUS INSERT

CH, HM



01960722-1

.72" H x .25" T x 96" L



01960122-1

2.2" H x .5" T x 96" L

MISSION INSERT

AK, CH, HM



01960710-1

.72" H x .25" T x 96" L



01960110-1

2.2" H x .5" T x 96" L



Pictured: Weaved Insert in Panel Moulding

WEAVED INSERT

CH, HM



01960770-1

.72" H x .25" T x 96" L



01960170-1

2.2" H x .5" T x 96" L

NOUVEAU INSERT

AK, CH, HM



01960757-1

.72" H x .25" T x 96" L



01960157-1

2.2" H x .5" T x 96" L

CELTIC INSERT

AK, CH, HM



01960725-1

.72" H x .25" T x 96" L



01960125-1

2.2" H x .5" T x 96" L

PINNACLE INSERT

CH, HM, WK



01960716-1

.72" H x .25" T x 96" L



01960116-1

2.2" H x .5" T x 96" L

MADELINE INSERT

CH, HM, WK



01960715-1

.72" H x .312" T x 96" L



01960115-1

2.2" H x .719" T x 96" L

TILES

ACANTHUS LEAF ONLY

CH, HM



01910123-1

2.5" W x .5" T x 3" L

01912523-1

3.5" W x .75" T x 4.25" L

ACANTHUS SQUARE TILE

CH, HM



01902023-1

2.875" SQ. x .5" T

CELTIC TILE

AK, CH, HM



01902025-1

2.875" SQ. x .5" T

GAELIC ROSETTE

CH, HM



01901027-1

2.75" SQ. x .625" T

LONG PINNACLE TILE

CH, HM



01901016-1

5.938" W x .75" T x 2.938" L

MISSION TILE

CH, HM, WK



01902111-1

2.875" SQ. x .4375" T

TRIAD TILE

CH, HM, WK



01901012-1

2.9375" SQ. x .875" T

INFINITY TILE

AK, CH, HM



01902538-1

5.9375" SQ. x 1.375" T



Available Finishes

Metal Finishes

- CR: Chrome
- PB: Polished Brass
- SB: Satin Brass
- SS: Stainless Steel
- WR: Flat Black

Featured:
Polished Brass
Gallery Rail

Attach Gallery Rail components to the tops of cabinets, furniture, shelving, spice racks, and more to create an eye-catching, curated, and luxury look. Typical spacing between posts across the front is approximately 6" - 10" apart. Manufactured from the finest quality cast brass, Gallery Rail components will not tarnish, rust, peel, or chip. Gallery Rail Sample Kits available on our website.

BRASS GALLERY RAIL

CR, SB, PB, WR

CORNER POST



01HC9002-1
 .906" DIAM. x 1.575" H

END POST



01HC9003-1
 .906" DIAM. x 1.575" H

CENTER POST



01HC9001-1
 .906" DIAM. x 1.575" H

ROD



01HC900436-1
 6 mm DIAM. x 36" L

CONTEMPORARY GALLERY RAIL

SS

END POST



01HC9013SS1
 .906" DIAM. x 1.575" H
Corner Adapter: 01HC8012SS1
 1.102" DIAM. X 1.654"H

CENTER POST



01HC9011SS1
 .906" DIAM. x 1.575" H

ROD



01HC900436SS1
 6 mm DIAM. x 36" L

APEX CORNER STRAPS W/ MATCHING LAG BOLTS

Apex Corner Straps work with multiple sized columns, legs, shelves, and corbels. These 2" & 3" straps are an ideal way to add a touch of metal to designs. Each strap comes complete with pyramid head screws in matching finishes.



Pictured: Apex Corner Strap

APEX CORNER STRAPS

GL, GR, WR

Pictured in Flat Black



01STR200-1
 2" Each Way x .125" T x 1" H



01STR300-1
 3" Each Way x .125" x 1.5" H

BRASS APEX STRAPS

AB, PB









Pictured in Polished Brass



01HC1008-1
 2" Each Way x .188" T x 1.5" H



Available Species

-  **AK:** Red Oak
-  **AL:** Alder
-  **CH:** Cherry
-  **HM:** Hard Maple
-  **HK:** Hickory
-  **PT:** Paint Grade
-  **QS:** Qtr Sawn Red Oak
-  **WK:** White Oak
-  **WL:** Walnut

Featured:
Grate Style Toe
Kick Vent

SINGLE OUTLET



01450002-1

3.5" W x .375" T x 5.75" H

DOUBLE OUTLET



01451002-1

5.5" W x .375" T x 5.75" H

SINGLE ROCKER



01450003-1

3.5" W x .375" T x 5.75" H

DOUBLE ROCKER



01451003-1

5.5" W x .375" T x 5.75" H

AK, AL, CH, HM, HK, QS, WK, WL

TRIPLE ROCKER



01453003-1

7.313" W x .375" T x 5.75" H

QUAD ROCKER



01454003-1

9.125" W x .375" T x 5.75" H

AK, AL, CH, HM, QS, WK, WL

SINGLE SWITCH



01450001-1

3.5" W x .375" T x 5.75" H

DOUBLE SWITCH



01451001-1

5.5" W x .375" T x 5.75" H

AK, AL, CH, HM, QS, WK, WL

TRIPLE SWITCH



01453001-1

7.313" W x .375" T x 5.75" H

QUAD SWITCH



01454001-1

9.125" W x .375" T x 5.75" H

AK, AL, CH, HM, QS, WK, WL

SWITCH COMBO 1



01450012-1

5.5" W x .375" T x 5.75" H

SWITCH COMBO 2



01451012-1

7.313" W x .375" T x 5.75" H

SWITCH COMBO 3



01450013-1

5.5" W x .375" T x 5.75" H

SINGLE BLANK
 SWITCH PLATE COVER



01452001-1

3.5" W x .375" T x 5.75" H

DOUBLE BLANK
 SWITCH PLATE COVER



01452002-1

5.5" W x .375" T x 5.75" H

SWITCH COMBO 4



01451013-1

7.313" W x .375" T x 5.75" H

ELECTRICAL BOX ROUTING



Let the design of your kitchen island speak for itself. Make one of its most functional yet unsightly components, the electrical outlet, inconspicuous. Integrate electrical outlets into your design and create the perfect union of form and function.

We offer Electrical Box Routing and Electrical Boring to most columns greater than 3"W. Electrical Box Routing allows you to install electrical components directly into the column. For additional electrical wiring, we can bore a ½" hole through the entire length of the column.

AVAILABLE FOR MOST COLUMNS.
 CALL FOR AVAILABILITY.

GRATE STYLE TOE KICK VENT

AK, AL, CH, HM, WK, WL

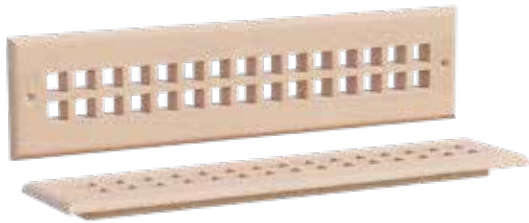

01992114-1

15.75" W x .75" T x 3.75" H



01992110-1

11.75" W x .75" T x 3.75" H



01992124-1

25.75" W x .75" T x 3.75" H



01992112-1

13.75" W x .75" T x 3.75" H

LINEAR STYLE TOE KICK VENT

AK, AL, CH, HM, WK, WL



01992214-1

15.75" W x .75" T x 3.75" H



01992224-1

25.75" W x .75" T x 3.75" H



01992210-1

11.75" W x .75" T x 3.75" H



01992212-1

13.75" W x .75" T x 3.75" H

SELF RIMMING TOE KICK VENT

AK, AL, CH, HM, WK, WL



01992010-1

11.75" W x .75" T x 3.625" H



01992012-1

13.75" W x .75" T x 3.75" H



01992014-1

15.75" W x .75" T x 3.75" H

SELF RIMMING FLOOR VENT

AK, AL, CH, HM, WK, WL



01994012-1

13.75" W x .75" T x 5.75" H



01994010-1

11.75" W x .75" T x 5.75" H

Designs of distinction®

Kitchen, Bath & Home
by BWI

Elevate your designs with the sophistication of Brass Bistro Shelving. Flush, Traditional, and Cantilever Bistro Shelving Kits are stocked in Lacquered Polished Brass & Satin Brass, with 8 custom finishes available. To see all Brass Bistro Shelving finishes we offer, order a Brass Sample Kit or visit our website.

BRASS BISTRO KITS

GLASS SHELVES NOT INCLUDED

Our Brass Bistro Shelving is easy to assemble with set screws and includes installation hardware and assembly instructions.

PB, SB

CANTILEVER



ONLY FOR 10" SHELVES:

3 SHELF

01CANT1036-1

36" high, 13" deep

4 SHELF

01CANT1048-1

48" high, 13" deep

FLUSH



FOR 10" SHELVES:

3 SHELF

01FLUSH1036-1

42" high,
12.875" deep

4 SHELF

01FLUSH1048-1

56.5" high,
12.875" deep

FOR 12" SHELVES:

3 SHELF

01FLUSH1236-1

42" high,
14.875" deep

4 SHELF

01FLUSH1248-1

56.5" high,
14.875" deep

FOR 10" SHELVES:

3 SHELF

01TRAD1036-1

42.25" high,
13.375" deep

4 SHELF

01TRAD1048-1

56.375" high,
13.375" deep

TRADITIONAL



FOR 12" SHELVES:

3 SHELF

01TRAD1236-1

42.25" high,
15.375" deep

4 SHELF

01TRAD1248-1

56.375" high,
15.375" deep

Wall-to-floor, ceiling-to-countertop, wall-to-countertop... you decide your connection points, number of shelves, and more by designing your custom Bistro Shelving. We offer built-to-order Bistro Shelving in multiple configurations and 8 finishes.

Contact us or send us an order form with your specifications and a quote will be provided.



Traditional Bistro Shelving in Satin Nickel

Stock Finishes



PB: Lacquered Polished Brass



SB: Lacquered Satin Brass

POT RAIL KIT

All 3 sizes Include 6 matching "S" hooks.

PB, SB, WR



01POTRL1-24-1 1" Diam. Pot Rail Kit - 24" L



01POTRL1-30-1 1" Diam. Pot Rail Kit - 30" L





01POTRL1-36-1 1" Diam. Pot Rail Kit - 36" L

CUSTOM SIZES & FINISHES AVAILABLE

Brass Bistro Shelving Kits and Pot Rail Kits are available in 8 custom finishes.



Stock Finishes

-  **PB:** Lacquered Polished Brass
-  **SB:** Lacquered Satin Brass
-  **WR:** Flat Black



Warranty

Wood, Iron and Metal Components:

- Our liability shall not exceed the replacement cost of our products.
- Defect on the material or workmanship must be reported upon receipt and prior to installation.
- Prompt and proper sealing and finishing is essential to maintain wood stability. Sealing the ends of legs, bun feet and posts, backs and tops of corbels, etc. will reduce the chance of cracking due to moisture loss or moisture increase.
- We do not recommend our stock wood products for exterior use - Doing so will void the warranty.
- **WOOD PRODUCTS MUST BE MAINTAINED UNDER STABLE TEMPERATURE AND HUMIDITY CONDITIONS TO REMAIN UNDER WARRANTY.**
- Defects caused by abuse, negligence, or damage from installation are not covered. Damages arising from improper or incorrect installation are not covered.
- Metal finishes may be subject to small variations. Designs of Distinction® is not responsible for color variations and cannot guarantee exact matches between similar items.
- Any product that is proven to be defective in workmanship or material is returned to Designs of Distinction® within the applicable warranty period. Designs of Distinction® will, at its option, either repair, replace or credit the customer for the purchase price of the product. This warranty extends only to persons or organizations that originally purchase the product from Designs of Distinction®.

Product Information

Decorative Wire Grille and Mesh:

- Interior applications only. Use of this product on exterior applications will void the warranty.
- Can be cleaned easily with any NON-AMMONIA based cleaners.

Rattan:

Rattan is a natural product and will vary from sheet to sheet in color. Because our rattan is hand-woven, no two sheets are alike. Rattan will change color as it ages, will fade from the sun, or mold if left in a damp location. Rattan can be cleaned with mild soap and water. Stretching and shrinking of your rattan insert is not considered a defect as this is part of the natural material characteristics.

Anodized Aluminum:

- **Anodizing Color Range:** Variation in gloss, light & dark, and tristimulus system values (RGB) should be expected. Because anodized coatings are translucent, appearance will vary with viewing angle and base level finish of material.
- **Anodized Aluminum Racking Marks:** All anodized aluminum extrusion and parts must have electrical contact to the part to be anodized. Various contact types are used depending upon the size and geometry of the part being anodized. The electrical contact will leave racking marks on the finished parts. Racking marks include bolt marks, clip marks or thread marks. We strive to minimize the visual impact of racking marks on all of our anodized products but cannot guarantee they will be completely mark free.
- **Exterior Use:** Anodized aluminum parts can be used outdoors but colors may fade overtime. If you are concerned about your color fading, we recommend you do not use this product on an exterior application.

PART # / PAGE #

MATERIALS - TAMBOUR

011248100-1	9
011248101-1	8
011248102-1	9
011248103-1	8
011248104-1	7
011248105-1	7
011248106-1	7
011248107-1	9
011248110-1	9
011248201-1	8
011248202-1	8
011248203-1	7
011248204-1	7
011248206-1	7
011248207-1	7
011248302-1	10
011248304-1	10
011248402-1	10
011248403-1	10
011296100-1	9
011296101-1	8
011296102-1	9
011296103-1	8
011296104-1	7
011296105-1	7
011296106-1	7
011296107-1	9
011296110-1	9
011296201-1	8
011296202-1	8
011296203-1	7
011296204-1	7
011296206-1	7
011296207-1	7
011296304-1	10
011296402-1	10
011296403-1	10
012446100-1	9
012446102-1	9
012446107-1	9
012446110-1	9
012446304-1	10
012446402-1	10
012446403-1	10

PART # / PAGE #

012448100-1	9
012448102-1	9
012448107-1	9
012448110-1	9
012448304-1	10
012448402-1	10
012448403-1	10

MATERIALS - METAL ACCENT TRIM

01110030-1	11
01110171-1	11
01110451-1	11
01110451-1	
DripEdge	12
01110788-1	12
01110810-1	12
01HC1000-1	13
01HC1001-1	13
01HC1002-1	13
01HC1003-1	13
01HC1004-1	13
01HC1005-1	13
01HC1006PB1	13
01HC1007PB1	13
01HC1009-1	13
01STRAP7572-1	11
01TP1875-54	13
01TP1875-8	13
01TP50-108	13
01TP50-8	13

MATERIALS - CUT-TO-SIZE

0124481802	16
0124481803	16
0124481804	16
0148481802	16
0148481803	16
0148481804	16
01184811614P-1	15
0118481214F-1	14
0118481220T-1	15
011848286S-1	15
011848315C-1	14
011848332P-1	15
011848CG10-1	14

PART # / PAGE #

011848DK08-1	15
011848R332PAB1	16
011848R614PAB1	16
011848RE25-1	14
0124481652-1	17
0124482216-1	17
012448MESH-1	17
01247211614P-1	15
0124721214F-1	14
012472286S-1	15
012472332P-1	15
012472DK08-1	15
01362411614P-1	15
0136241214F-1	14
0136241220T-1	15
013624286S-1	15
013624315C-1	14
013624332P-1	15
013624CH10-1	14
013624DK08-1	15
013624R332PAB1	16
013624R614PAB1	16
013624RE25-1	14
01364811614P-1	15
0136481202NT1	16
0136481203NT1	16
0136481204NT1	16
0136481214F-1	14
0136481220T-1	15
013648286S-1	15
013648315C-1	14
013648332P-1	15
013648CG10-1	14
013648DK08-1	15
013648R332PAB1	16
013648R614PAB1	16
013648RE25-1	14
014448MESH-1	17
0148481652-1	17
0148482216-1	17
015936104SS1	17
015936107-1	17
015936112SS1	17
015936116SS1	17
015936118SS1	17

PART # / PAGE #

01DGRETAINDER-1	17
POSTS, COLUMNS & TABLE LEGS	
01000110-1	30
01000210-1	30
01000310-1	30
01010280-1	29
01010285-1	29
01020280-1	29
01030210-1	30
01040127-1	32
01040160-1	32
01040210-1	28
01040240-1	28
01040260-1	32
01040270-1	32
01040275-1	32
01042760-1	32
01050210-1	33
01060110-1	33
01060160-1	33
01060210-1	33
01060220-1	33
01060260-1	33
01080210-1	35
01080230-1	35
01080240-1	35
01080270-1	35
01082710-1	35
01082730-1	35
01082740-1	35
01090215-1	36
01100211-1	36
01100218-1	36
01110110-1	32
01110210-1	32
01110218-1	36
01140210-1	37
01150220-1	34
01160210-1	34
01160310-1	34
01180210-1	20
01180240-1	20
01210110-1	30
01210210-1	30

PART # / PAGE #		PART # / PAGE #		PART # / PAGE #		PART # / PAGE #	
01220160-1	32	01550240-1	20	01632010-1	26	BUN FEET	
01220260-1	32	01560210-1	34	01633010-1	26	01240006-1	49
01230210-1	35	01560222-1	37	01634010-1	26	01240009-1	49
01230230-1	35	01570217-1	37	01635010-1	26	01241006-1	49
01230240-1	35	01570317-1	37	01636010-1	26	01241009-1	49
01230270-1	35	01580217-1	37	01722010-1	22	01242006-1	49
01240210-1	36	01580317-1	37	01722910-1	21	01242009-1	49
01240310-1	36	01590122-1	31	01723001-1	23	01243006-1	44
01250210-1	20	01590123-1	31	01723010-1	23	01243009-1	44
01250310-1	20	01590124-1	31	01724001-1	24	01244006-1	44
01270110-1	27	01590125-1	31	01724010-1	24	01244009-1	44
01270110-3	27	01590127-1	31	01724500-1	22	01245106-1	44
01270210-1	27	01590128-1	31	01724529-1	21	01245109-1	44
01270210-3	27	01590210-1	34	01725001-1	25	01700011-1	48
01280110-1	27	01590222-1	31	01725010-1	25	01700012CR1	50
01280110-3	27	01590223-1	31	01732010-1	26	01700015-1	48
01280210-1	27	01590224-1	31	01733010-1	26	01700018-1	47
01280210-3	27	01590225-1	31	01734010-1	26	01700146-1	45
01290180-1	29	01590227-1	31	01734510-1	23	01700210-1	46
01290280-1	29	01590228-1	31	01735010-1	26	01700245-1	49
01310110-1	28	01606010-1	25			01700310-1	46
01310110-3	28	01610210-1	34	END PANELS		01700327-1	45
01310210-1	28	01612010-1	21	& METAL BASES		01700345-1	49
01310210-3	28	01612010-3	21	01XBS2824WR1	41	01700400CR1	50
01370210-1	30	01613010-1	23	01XBS3424WR1	41	01700401-1	50
01410110-1	33	01613025-1	23	01XBS3436WR1	41	01700402CR1	50
01410210-1	33	01614010-1	24	01XCONT2824SS1	41	01700406-1	50
01470110-1	30	01614025-1	24	01XCONT2824WR1	41	01700408-1	50
01470210-1	30	01615010-1	25	01XPN1525LNG-1	39	01700410-1	50
01510110-1	33	01621025-1	21	01XPN1525LNG-4	40	01700412-1	50
01510200-1	34	01621025-3	21	01XPN1536LNG-1	39	01700427-1	45
01510202-1	34	01621729-1	23	01XPN1536LNG-4	40	01700457-1	45
01510203-1	29	01622010-1	22	01XPN3025LNG-1	39	01700627-1	45
01510204-1	36	01622010-3	22	01XPN3025LNG-4	40	01700905CR1	50
01510210-1	33	01622025-1	22	01XPN3036LNG-1	39	01702022-1	44
01510228-1	20	01622025-3	22	01XPN3036LNG-4	40	01702510-1	48
01510328-1	20	01623010-1	23	01XPNL1525-1	39	01703010-1	43
01515028-1	20	01623017-1	23	01XPNL1525-4	40	01703110-1	43
01520210-1	34	01623025-1	23	01XPNL1536-1	39	01703210-1	43
01520223-1	37	01624010-1	24	01XPNL1536-4	40	01703310-1	43
01530210-1	28	01624025-1	24	01XPNL3025-1	39	01703510-1	46
01530310-1	28	01625010-1	25	01XPNL3025-4	40	01704010-1	48
01540210-1	28	01625046-1	36	01XPNL3036-1	39	01704017-1	50
01540310-1	28	01626010-1	25	01XPNL3036-4	40	01704040-1	48
01550210-1	20	01626050-1	36			01704060-1	45

PART # / PAGE #

01704075-1	46
01704110-1	48
01704210-1	48
01704245-1	49
01704535-1	48
01704910-1	48
01705080-1	45
01705110-1	46
01705112-1	46
01705150-1	46
01705155-1	47
01705175-1	46
01705225-1	47
01705310-1	48
01705510-1	46
01705515-1	47
01705610-1	46
01705710-1	45
01705715-1	46
01705810-1	46
01706005-1	48
01706010-1	48
01706018-1	50
01706035-1	48
01706060-1	47
01706061-1	47
01706065-1	45
01707410-1	44
01707440-1	44
01707610-1	44
01707710-1	44
01708010-1	43
01708110-1	43
01708310-1	43
01709010-1	44
01709035-1	48
01710610-1	50
01710910-1	50
01721010-1	49
01731010-1	49
01742060-1	45
01750460-1	45
01760410-1	48
01FRC1010-1	51
01FRC1040-1	51

PART # / PAGE #

01FRS1010-1	51
01FRS1254-1	51
01SLPR101-1	51
01SLPR103-1	51
01SLPR104-1	51
01SLPR105-1	51
01SLPR106-1	51
01SLPR107-1	51
01SLV2-1	49
01SLV245-1	51
01SLV3-1	49
01SLV345-1	51
01SLV4-1	49
01SLV5-1	49
BRACKETS & CORBELS	
01600004-1	53
01600006-1	53
01600009-1	55
01600016-1	53
01600300-1	53
01600318-1	60
01600418-1	60
01600518-1	60
01600627-1	63
01600628-1	63
01600637-1	61
01600927-1	63
01600928-1	63
01600937-1	61
01601100-1	56
01601203-1	60
01601204-1	60
01601205-1	60
01601206-1	60
01601300-1	56
01601400-1	56
01601427-1	63
01601450-1	55
01604500-1	57
01604505-1	57
01604510-1	57
01605000-1	64
01605001-1	64
01605002-1	64

PART # / PAGE #

01605005-1	64
01605006-1	54
01605007-1	54
01605008-1	54
01605009-1	54
01605510-1	53
01606001-1	58
01606002-1	58
01606003-1	58
01606005-1	58
01607001-1	57
01607002-1	53
01607003-1	55
01607004-1	57
01607005-1	57
01607006-1	55
01607007-1	55
01607008-1	55
01607009-1	55
01607010-1	58
01607011-1	58
01607012-1	53
01607013-1	58
01607117-1	56
01607215-1	61
01607216-1	61
01607217-1	56
01607315-1	61
01607316-1	61
01607317-1	56
01608001-1	59
01608007-1	59
01608008-1	59
01608009-1	59
01608010-1	59
01608011-1	59
01608013-1	59
01609001-1	62
01609003-1	62
01609004-1	62
01901001-1	62
01901002-1	62
01901003-1	61
01901004-1	64
01901005-1	61

PART # / PAGE #

01901009-1	62
01901105-1	62
01901107-1	62
01901108-1	62
01904990-1	64
01904991-1	64
01904993-1	64
CREATE-A-COLUMN	
01311510-2	67
01312010-2	67
01321510-2	67
01322010-2	67
01331510-2	67
01332010-2	67
01384210-2	66
01384240-2	66
01391510-2	67
01961510-2	66
01961520-2	66
01961530-2	66
01961540-2	66
01962010-2	66
01962020-2	66
01962040-2	66
SHELVING	
01650850-1	72
01650860-1	72
01651250-1	72
01651260-1	72
01651270-1	72
01980109WR1	71
01980116WR1	71
01981022WR1	71
01981515WR1	71
01982222WR1	71
01CHSHLF0424-1	73
01CHSHLF0424-1 (METAL)	73
01CHSHLF0424-1 (WOOD)	74
01CHSHLF0436-1 (METAL)	73
01CHSHLF0436-1 (WOOD)	74

PART # / PAGE #

01CHSHLF0448-1	
(METAL)	73
01CHSHLF0448-1	
(WOOD)	74
01CHSHLF0460-1	
(METAL)	73
01CHSHLF0460-1	
(WOOD)	74
01CHSHLF0624-1	73
01CHSHLF0636-1	73
01CHSHLF0648-1	73
01CHSHLF0660-1	73
01FL102410-1	70
01FL103030-1	70
01FL103610-1	70
01HC1008-1	72, 82
01MFL102410-1	69
01MFL102424-1	69
01MFL103030-1	69
01MFL103610-1	69
01MFL104810-1	69
01MSH122424-1	69
01MSH123030-1	69
01SH083610-1	70
01SH086010-1	70
01SH123030-1	70
01SH123610-1	70
01SH126010-1	70
01STR200-1	72, 82
01STR300-1	72, 82

MOULDINGS & TILES

01806000-1	76
01807000-1	76
01807375-1	76
01807500-1	76
01827578-1	76
01860510-1	77
01860520-1	77
01901012-1	80
01901016-1	80
01901027-1	80
01902023-1	80
01902025-1	80
01902111-1	80
01902538-1	80

PART # / PAGE #

01910123-1	80
01912523-1	80
01960110-1	78
01960115-1	79
01960116-1	79
01960122-1	78
01960125-1	79
01960127-1	78
01960137-1	78
01960145-1	78
01960157-1	79
01960170-1	79
01960710-1	78
01960715-1	79
01960716-1	79
01960722-1	78
01960725-1	79
01960727-1	78
01960737-1	78
01960745-1	78
01960757-1	79
01960770-1	79
01MB867510-1	77
01MB867520-1	77
01SHIPLAP-1	76

FINISHING TOUCHES & HARDWARE COMPONENTS

01HC9002-1	82
01HC9003-1	82
01HC9001-1	82
01HC900436-1	82
01HC9013SS1	82
01HC8012SS1	82
01HC9011SS1	82
01STR200-1	72, 82
01STR300-1	72, 82
01HC1008-1	72, 82

**FINISHING TOUCHES:
 OUTLET COVERS
 & FLOOR VENTS**

01450001-1	84
01450002-1	84
01450003-1	84
01450012-1	85
01450013-1	85

PART # / PAGE #

01451001-1	84
01451002-1	84
01451003-1	84
01451012-1	85
01451013-1	85
01452001-1	85
01452002-1	85
01453001-1	84
01453003-1	84
01454001-1	84
01454003-1	84
01992010-1	87
01992012-1	87
01992014-1	87
01992110-1	86
01992112-1	86
01992114-1	86
01992124-1	86
01992210-1	86
01992212-1	86
01992214-1	86
01992224-1	86
01994010-1	87
01994012-1	87

BISTRO SHELVING

01CANT1036-1	88
01CANT1048-1	88
01FLUSH1036-1	88
01FLUSH1048-1	88
01FLUSH1236-1	88
01FLUSH1248-1	88
01TRAD1036 -1	88
01TRAD1048-1	88
01TRAD1236-1	88
01TRAD1248-1	88
01POTRL1-24-1	89
01POTRL1-30-1	89
01POTRL1-36-1	89



Designs of distinction[®]
Kitchen, Bath & Home by BWI

Distributed by:



616-245-4415 • sales@directsupplyinc.com • www.directsupplyinc.com